



PowerShot G3

DIGITAL CAMERA

Camera User Guide



- Please start by reading the Read This First on page 4 of this manual. Please refer to the *Software Starter Guide* for information on installing the software and downloading images.
- Please also read the printer user guide included with your Canon printer.

Exit Print



Flowchart and Reference Guides

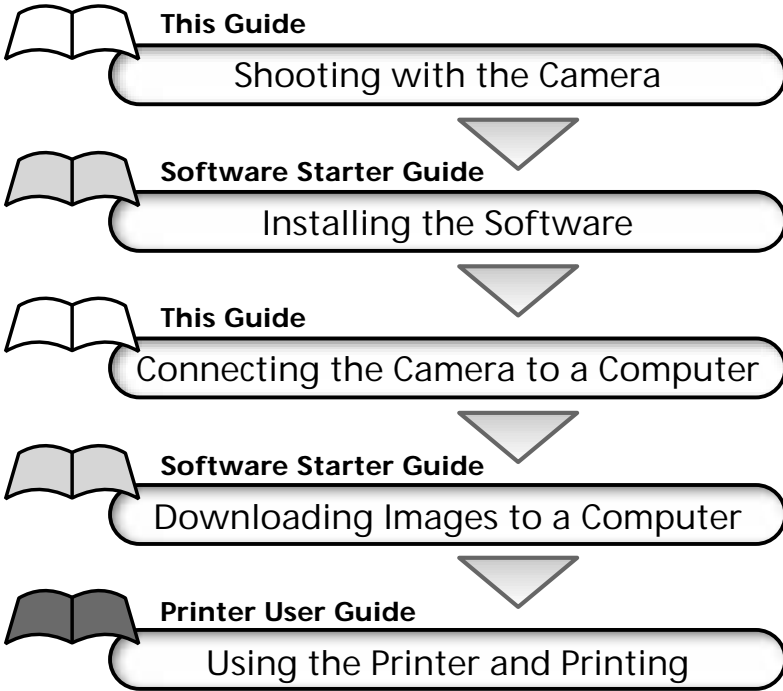

Precautions

This digital camera is designed to perform optimally when used with genuine Canon brand digital camera accessories ("Canon Brand Accessories"). You may use non Canon Brand Accessories with this Digital Camera. However, Canon makes no warranties concerning, and is not responsible for damages resulting from, use of non Canon Brand Accessories.

Camera Body Temperature

If your camera is used for prolonged periods, the camera body may become warm. Please be aware of this and take care when operating the camera for an extended period.

About the LCD Monitor

The LCD monitor is produced with extremely high-precision manufacturing techniques. More than 99.99% of the pixels operate to specification. Less than 0.01% of the pixels may occasionally misfire or appear as red or black dots. This has no effect on the recorded image and does not constitute a malfunction.

Video Format

Please set the camera's video signal format to the one used in your region before using it with a TV monitor (p. 165).

Language Setting

Please see page 26 to change the language setting.

Please read through the "Read This First" section (p. 4) before using your camera.

Disclaimer

- While every effort has been made to ensure that the information contained in this guide is accurate and complete, no liability can be accepted for any errors or omissions.
- Canon reserves the right to change the specifications of the hardware and software described herein at any time without prior notice.
- No part of this guide may be reproduced, transmitted, transcribed, stored in a retrieval system, or translated into any language in any form, by any means, without the prior written permission of Canon.
- Canon makes no warranties for damages resulting from corrupted or lost data due to a mistaken operation or malfunction of the camera, the software, the CompactFlash™ cards (CF cards), personal computers, peripheral devices, or use of non-Canon CF cards.

Trademark Acknowledgements

- Canon, PowerShot and Bubble Jet are trademarks of Canon, Inc.
- CompactFlash is a trademark of SanDisk Corporation.
- iBook and iMac are trademarks of Apple Computer, Inc.
- Macintosh, PowerBook, Power Macintosh and QuickTime are trademarks of Apple Computer, Inc, registered in the United States and other countries.
- Microsoft, Windows, and Windows NT are either registered trademarks or trademarks of Microsoft Corporation in the United States and/or other countries.
- Other names and products not mentioned above may be registered trademarks or trademarks of their respective companies.

Copyright ©2002 Canon Inc. All rights reserved.

About this Camera User Guide

Symbols Used



: This mark denotes issues that may affect the camera's operation.



: This mark denotes additional topics that complement the basic operating procedures.

Question? Look Here First.

- How do I navigate the menus?

Selecting Menus and Settings (p. 42)

- What settings are available under each function?

and

Will my settings remain in effect even after I've turned the camera off?

Functions Available in Each Shooting Mode (p. 204)

- How do I go about printing?

About Printing (p. 132)

- What functions are available through the menus?

Rec. Menu (p. 158)

Replay Menu (p. 161)

Set up Menu (p. 162)

My Camera Menu (p. 166)

About the Thumb Index

A quick introduction intended for new users who want to shoot first and learn more later. Tells you how to get the camera running and how to begin shooting and playing back images.

Quick Start

Introduces you to all of the camera components, and explains how to load batteries and use the shutter button, among other basic functions. Also explains how to set the camera's start-up image, and start-up, shutter and operation sounds.

Preparing the Camera,
Basic Functions

Describes shooting with the camera, from each shooting mode to using the camera's various shooting features.

Shooting

Explains how to review recorded images or select replay settings, how to protect images or erase them, and how to edit movies.

Replaying, Erasing

Explains how to print and make print settings, and how to select images for transferring to e-mail.

Printing,
Transferring

Explains how to transfer images to a computer. Also explains how to use a TV set for shooting and reviewing images. You must read this section before connecting your camera to a computer.



Connecting

















Shows the Rec., Replay, Set up and My camera menus at a glance and error messages. Also explains how to use the wireless controller and various separately sold accessories such as the charge adapter / car battery kit, externally mounted flash units and conversion lenses.

Appendix

Table of Contents

■ : Functions and operations tables. These pages are shaded on the right edges to make them easy to find.

Read This First	4
Quick Start	8
Components Guide	10
Front View	10
Back / Bottom View	11
Controls	12
Mode Dial	13
Main Dial	14
Display Panel	15
Preparing the Camera	16
Charging the Battery Pack	16
Installing the Battery Pack	19
Using Compact Power Adapter	21
Installing a CF Card	22
Setting the Date / Time	24
Setting the Language	26
Attaching the Strap	27
Attaching the Lens Cap	27
Using the Soft Case (Optional)	27
Basic Functions	28
Turning the Power On / Off	28
Switching between Shooting and Replaying	31
Using the LCD Monitor	32
Using the Optical Viewfinder to Shoot	38
Pressing the Shutter Button	39
Using the Zoom (Focal Length)	41
Selecting Menus and Settings	42
Customizing the Camera (My Camera Settings)	46
Changing My Camera Settings	46
Registering the My Camera Settings	48
Shooting - Letting the Camera Select Settings	51
 Auto Mode	51
Reviewing an Image Right after Shooting	53
Changing the Resolution and Compression	55
Changing the File Format	58
 Using the Flash	60
 Portrait Mode	63

	Landscape Mode	63
	Night Scene Mode	64
	Stitch Assist Mode	65
	Movie Mode	68
	Macro Mode	69
	Self-Timer	70
	Digital Zoom	72
	Continuous Shooting	73
	Shooting - Selecting Particular Effects	75
P	Program AE	75
Tv	Setting the Shutter Speed	77
Av	Setting the Aperture	79
M	Manually Setting the Shutter Speed and Aperture	81
	Selecting an AF frame	82
	Switching between Light Metering Modes	83
	Adjusting the Exposure	85
WB	Setting the White Balance	86
	Changing the Photo Effect	89
ISO	Changing the ISO Speed	92
	Auto Exposure Bracketing (AEB Mode)	93
	Focus Bracketing (Focus-BKT Mode)	95
*	Locking the Exposure Setting (AE Lock)	97
*	Locking the Flash Exposure Setting (FE Lock)	99
	Switching between Flash Adjustment Settings	100
	Switching the Timing at which the Flash Fires	102
	Shooting Images at Set Intervals (Intervalometer)	103
	Shooting Problem Subjects for the Autofocus	105
	Switching between Focus Settings	108
C1 C2	Saving Custom Settings	109
	Using the ND Filter	110
	Setting the Auto Rotate Function	111
	Resetting the File Numbers	112
	Replaying	113
	Displaying Images Individually	113
	Magnifying Images	114
	Viewing Nine Images at a Time (Index Replay)	115
JUMP	Jumping Between Images	116
	Viewing Movies	117
	Editing Movies	119
	Rotating Images in the Display	121
	Attaching Sound Annotations to Images	122
	Automated Playback (Slide Show)	124

Protecting Images	128
Erasing	129
Erasing Images Individually	129
Erasing All Images	130
Formatting a CF Card	131
Printing	132
About Printing	132
Selecting from the Print Menu	134
Connecting the Camera to a Printer	136
Printing	139
Setting the Print Settings (Direct Print Function)	141
Print Settings (DPOF Print Settings)	145
Printing with DPOF Print Settings	150
Image Transfer Settings (DPOF Transfer Order)	152
Selecting Images for Transferring	152
Viewing Images on a TV Set	154
Downloading Images to a Computer	155
Downloading Directly from a CF Card	155
Connecting the Camera to a Computer Via the USB Cable	156
List of Menu Options and Messages	158
Rec. Menu	158
Replay Menu	161
Set up Menu	162
My Camera Menu	166
Resetting the Settings to Default	168
List of Error / Message Codes	169
List of Messages	170
Appendix	174
Using the Wireless Controller	174
Using an Externally Mounted Flash (Optional)	177
Using Conversion Lenses (Optional) / Close-up Lenses (Optional) ..	183
Using a Charge Adapter / Car Battery Cable Kit (Optional)	186
Replacing the Date Battery	188
Camera Care and Maintenance	190
Troubleshooting	191
Specifications	194
Index	200
Functions Available in Each Shooting Mode	204

Read This First

Please Read

Test Shots

Before you try to photograph important subjects, we highly recommend that you shoot several trial images to confirm that the camera is operating and being operated correctly. Please note that Canon, its subsidiaries and affiliates, and its distributors are not liable for any consequential damages arising from any malfunction of a camera or accessory, including CompactFlash™ cards, that results in the failure of an image to be recorded or to be recorded in a format that is machine sensible.

Warning Against Copyright Infringement

Please note that Canon digital cameras are intended for personal use and should never be used in a manner that infringes upon or contravenes international or domestic copyright laws and regulations. Please be advised that in certain cases the copying of images from performances, exhibitions, or commercial properties by means of a camera or other device may contravene copyright or other legal rights even if the image was shot for personal use.

Warranty Limitations

This camera's warranty is only effective in the country of sale. If a problem arises while the camera is in use abroad, please convey it back to the country of sale before proceeding with a warranty claim to a Canon Customer Support Help Desk.

For Canon Customer Support contacts, please see the Canon Limited Warranty supplied with your camera.

Safety Precautions

- Before using the camera, please ensure that you read and understand the safety precautions described below. Always ensure that the camera is operated correctly.
- The safety precautions noted on the following pages are intended to instruct you in the safe and correct operation of the camera and its accessories to prevent injuries or damage to yourself, other persons and equipment.
- In the next few pages, the term “equipment” refers primarily to the camera, its power supply accessories and an optional compact power adapter.

Warnings

- Do not aim the camera directly into the sun or at other intense light sources which could damage your eyesight.
- Do not trigger the flash in close proximity to human or animal eyes. Exposure to the intense light produced by the flash may damage eyesight. In particular, remain at least one meter (39 inches) away from infants when using the flash.

-
- Store this equipment out of the reach of children and infants. Accidental damage to the camera or batteries by a child could result in serious injury. In addition, placement of the strap around the child's neck could result in asphyxiation.
-
- Be particularly careful to keep the date battery used in the camera away from children. Seek medical assistance immediately if a child swallows a battery.
-
- Do not attempt to disassemble or alter any part of the equipment that is not expressly described in this guide. Disassembly or alteration may result in high-voltage electrical shock. Internal inspections, alterations and repairs should be conducted by qualified service personnel authorized by your camera distributor or a Canon Customer Support Help Desk.
-
- To avoid the risk of high-voltage electrical shock, do not touch the flash portion of the camera if it has been damaged. Similarly, never touch internal portions of the equipment that become exposed as a result of damage. There is a risk of high-voltage electrical shock. Please take the first opportunity to consult your camera distributor or a Canon Customer Support Help Desk.
-
- Stop operating the equipment immediately if it emits smoke or noxious fumes. Failure to do so may result in fire or electrical shock. Immediately turn the camera's power off, remove the camera battery and unplug the power cord from the power outlet. Confirm that smoke or fume emissions have ceased. Please consult your camera distributor or the closest Canon Customer Support Help Desk.
-
- Stop operating the equipment if it is dropped or the casing is damaged. Failure to do so may result in fire or electrical shock. Immediately turn the camera's power off, remove the camera battery and unplug the power cord from the power outlet. Please consult your camera distributor or the closest Canon Customer Support Help Desk.
-
- Do not allow the equipment to come into contact with, or become immersed in, water or other liquids. Do not allow liquids to enter the interior. The camera has not been waterproofed. If the exterior comes into contact with liquids or salt air, wipe it dry with a soft, absorbent cloth. In the event that water or other foreign substances enter the interior, immediately turn the camera's power off and remove the camera battery or unplug the power cord from the power outlet. Continued use of the equipment may result in fire or electrical shock. Please consult your camera distributor or the closest Canon Customer Support Help Desk.
-
- Do not use substances containing alcohol, benzene, thinners or other flammable substances to clean or maintain the equipment. The use of these substances may lead to fire.
-
- Remove the power cord on a regular periodic basis and wipe away the dust and dirt that collects on the plug, the exterior of the power outlet and the surrounding area. In dusty, humid or greasy environments, the dust that collects around the plug over long periods of time may become saturated with humidity and short-circuit, leading to fire.
-
- Do not cut, damage, alter or place heavy items on the power adapter cord. Any of these actions may cause an electrical short circuit, which may lead to fire or electrical shock.
-

-
- Do not handle the power cord if your hands are wet. Handling it with wet hands may lead to electrical shock. When unplugging the cord, ensure that you hold the solid portion of the plug. Pulling on the flexible portion of the cord may damage or expose the wire and insulation, creating the potential for fires or electrical shocks.
-
- Use of power sources not expressly recommended for this equipment may lead to overheating, distortion of the equipment, fire, electrical shock or other hazards. Use only the recommended power accessories.
-
- Do not place the batteries near a heat source or expose them to direct flame or heat. Neither should you immerse them in water. Such exposure may damage the batteries and lead to the leakage of corrosive liquids, fire, electrical shock, explosion or serious injury.
-
- Do not attempt to disassemble, alter or apply heat to the batteries. There is serious risk of injury due to an explosion. Immediately flush with water any area of the body, including the eyes and mouth, or clothing, that comes into contact with the inner contents of a battery. If the eyes or mouth contact these substances, immediately flush with water and seek medical assistance.
-
- Avoid dropping or subjecting the batteries to severe impacts that could damage the casings. It could lead to leakage and injury.
-
- Do not short-circuit the battery terminals with metallic objects, such as key holders. It could lead to overheating, burns and other injuries. Use the supplied terminal cover to transport or store the battery pack.
-
- Before you discard a battery, cover the terminals with tape or other insulators to prevent direct contact with other objects. Contact with the metallic components of other materials in waste containers may lead to fire or explosions. Discard the batteries in specialized waste facilities if available in your area.
-
- Use of batteries not expressly recommended for this equipment may cause explosions or leaks, resulting in fire, injury and damage to the surroundings. Use only recommended batteries and accessories.
-
- Disconnect the compact power adapter from both the camera and power outlet after recharging and when the camera is not in use to avoid fires and other hazards. Continuous use over a long period of time may cause the unit to overheat and distort, resulting in fire.
-
- The camera terminal of the supplied compact power cord is designed for exclusive use with your camera. Do not use it with other products or batteries. There is a risk of fire and other hazards.
-
- Exercise due caution when screwing on the separately sold wide converter lens, tele-converter lens, close-up lens and conversion lens adapter. If they loosen, fall off and shatter, the glass shards may cause an injury. Never aim the lenses at the sun or strong light sources. There is a risk of damage to eyesight.
-

Cautions

- Avoid using, placing or storing the equipment in places subject to strong sunlight or high temperatures, such as the dashboard or trunk (boot) of a car. Exposure to intense sunlight and heat may cause the batteries to leak, overheat or explode, resulting in fire, burns or other injuries. High temperatures may also cause deformation of the casing. Ensure that there is good ventilation when using the compact power adapter to charge the battery pack or power the camera.
- Do not store the equipment in humid or dusty areas. Storage in such areas could lead to fire, electrical shock or other damage.
- Be careful not to bang the camera or subject it to strong impacts or shocks that could lead to injury or damage the equipment when wearing or holding it by the strap.
- Be careful not to cover the flash with your fingers when shooting. In addition, do not touch the surface of the flash after taking several pictures in rapid succession. Either action could result in burns.
- If your camera is used for prolonged periods, the camera body may become warm. Please take care when operating the camera for an extended period as your hands may experience a burning sensation.

Preventing Malfunctions

■ Avoid Strong Magnetic Fields

Never place the camera in close proximity to electric motors or other equipment generating strong electromagnetic fields. Exposure to strong magnetic fields may cause malfunctions or corrupt image data.

■ Avoid Condensation Related Problems

Moving the equipment rapidly between hot and cold temperatures may cause condensation (water droplets) to form on its external and internal surfaces. You can avoid this by placing the equipment in an airtight, resealable plastic bag and letting it adjust to temperature changes slowly before removing it from the bag.

■ If Condensation Forms Inside the Camera

Stop using the camera immediately if you detect condensation. Continued use may damage the equipment. Remove the CF card, and battery or a household power source, from the camera and wait until the moisture evaporates completely before resuming use.

Quick Start

1

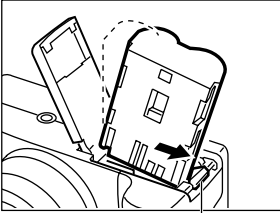

Battery lock

Install the Battery (p. 19).

Open the battery cover and insert the battery while pressing the battery lock.

2

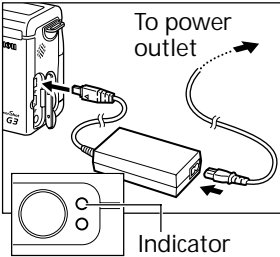

To power outlet

Indicator

Charge the Battery (p. 16).

Check that the power is off. Charge the battery. The battery is approximately 90% charged (adequate charge for use) when the orange indicator beside the viewfinder stops blinking and lights steadily. After charging, detach the compact power adapter's DC plug from the camera.

3

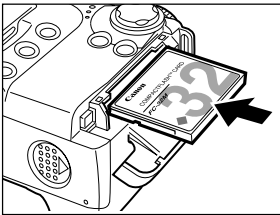

Install the CF card (p. 22).

4

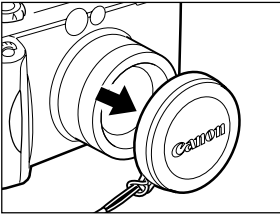

Remove the lens cap.

5

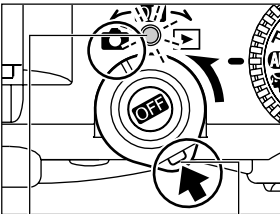

Power/Mode Indicator Release Button

Turn the power on (p. 28).

Open the LCD monitor and turn the mode lever to  (shooting) while pressing the release button.

The Power/Mode indicator lights orange.

6

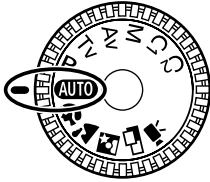

Turn the mode dial to **AUTO** (p. 51).

7

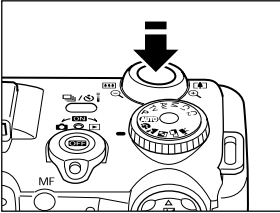

Focus (p. 39).

Aim the camera and lightly press the shutter button halfway. Two beeps will sound when the autofocus is set.

8

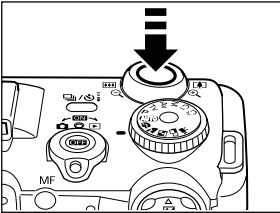

Shoot (p. 39).

Press the shutter button all the way. You will hear the sound of the shutter close when the shot is complete.

9



View the recorded image (p. 53).

The recorded image will display in the LCD monitor for approximately 2 seconds. Keep your finger on the shutter button or press the **SET** button while the image is displayed to continue to display the image after the shutter button is released.



To Immediately Delete the Displayed Image

1. Press the  button while the image is displayed.
2. Confirm that [Erase] is selected and press the **SET** button.
 - Once you are done, press the **OFF** button to turn off the power.



Front View

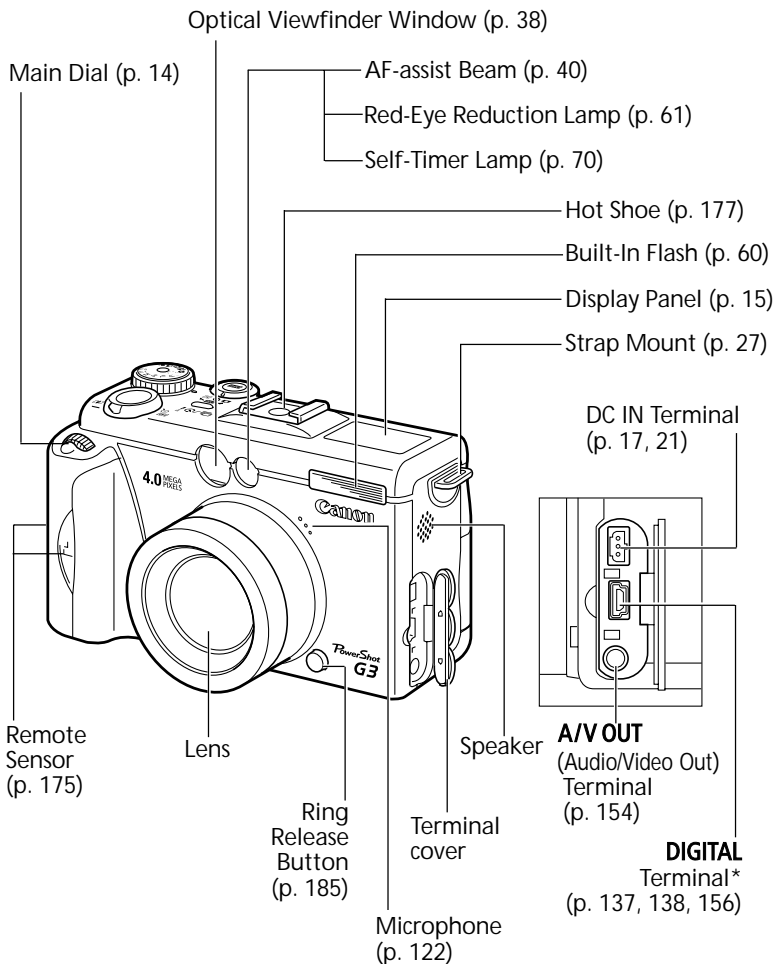

* To connect the camera to a computer or printer, use one of the following cables.

- Computer: USB Interface Cable IFC-300PCU (supplied with this camera)
- Direct Print Compatible Printer (optional): Direct Interface Cable DIF-100 (supplied with Direct Print compatible printers)
- Bubble Jet Printer with the direct print function (optional): Please refer to the Bubble Jet Printer user guide.

Please refer to your *System Map* to find out which direct print function compatible printers can be used with this camera.

Back / Bottom View

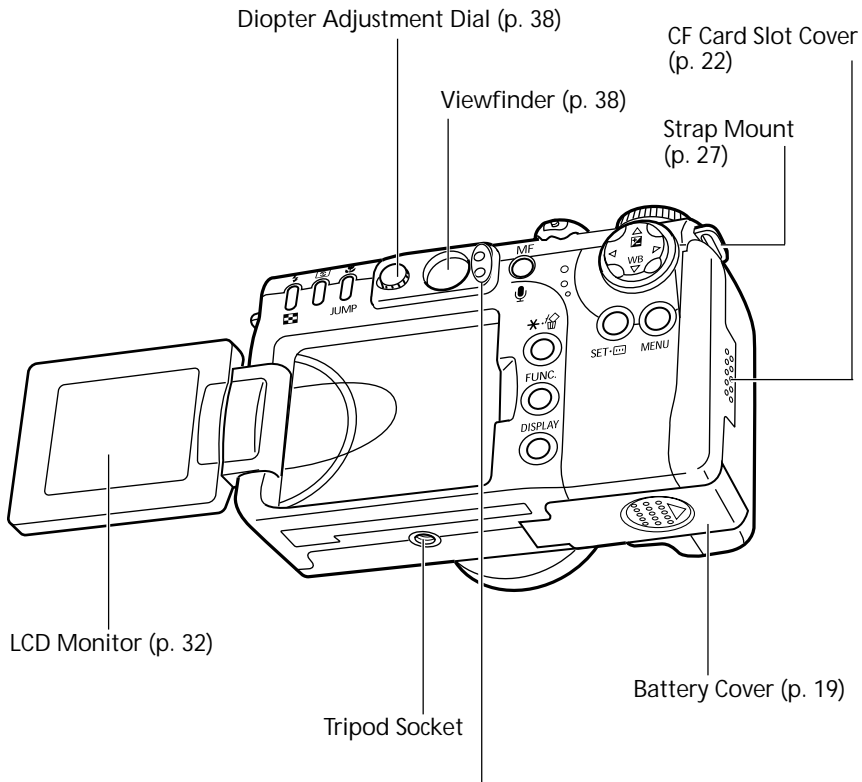

● Upper Indicator

The indicators light or blink when the shutter button is pressed or the following operations are underway.

- Green: Ready to record / Battery charge complete (100%)*
- Blinking Green: Recording to CF card / Reading CF card / Erasing from CF card/ Transmitting data (during a computer connection)
- Orange: Ready to record (flash on) / Battery charge at 90%*
- Blinking Orange: Ready to record (camera shake warning) / battery is charging (The interval between flashes may differ according to the charge state of the battery.)*

*Only displays when connected to the compact power adapter.

● Lower Indicator

- Yellow: Macro mode / Manual focus mode
- Blinking Yellow: Focusing difficulty (although you can press the shutter button, try using focus lock or adjusting the focus manually, p. 106)

Controls

Top

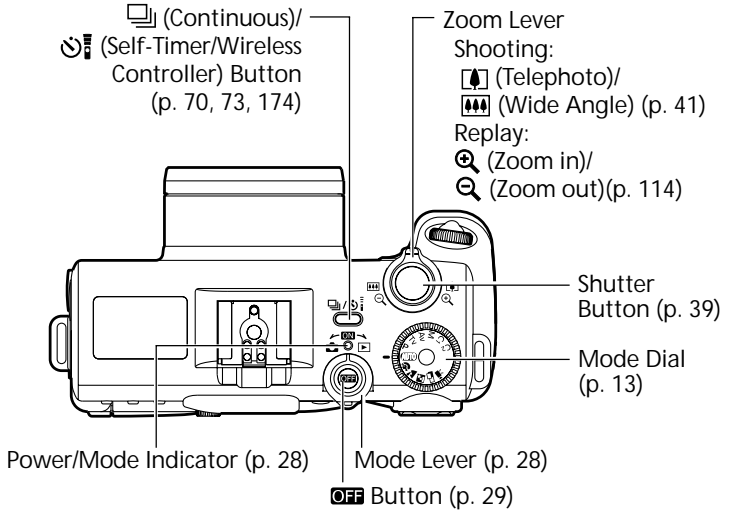



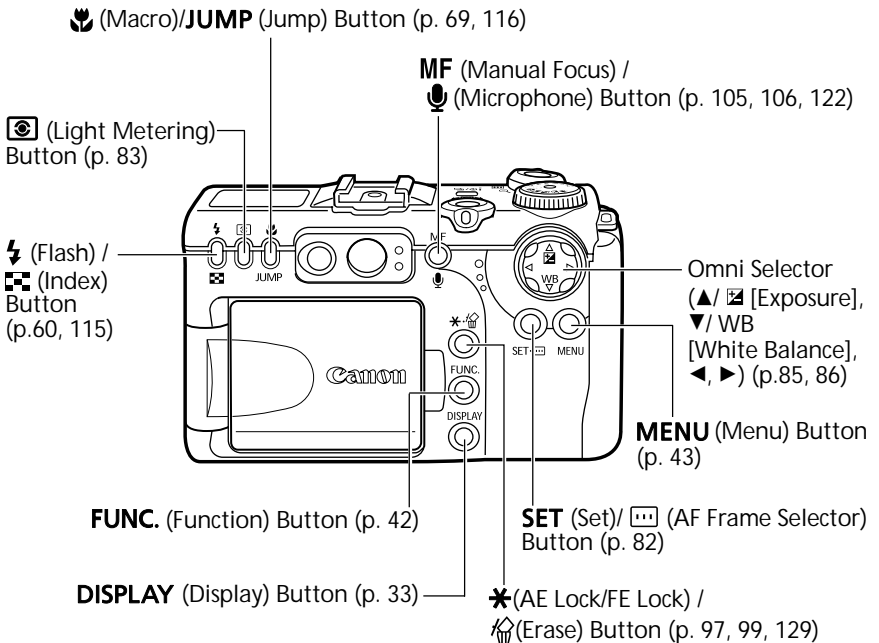



Back

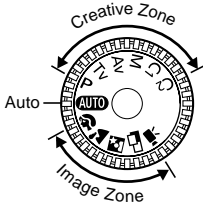

Mode Dial

Use the mode dial to switch between the shooting modes.



- **AUTO** : Auto (p. 51)
The camera automatically selects settings.
- Image Zone
The camera automatically selects settings according to the image composition type.
 -  : Portrait (p. 63)
 -  : Landscape (p. 63)
 -  : Night Scene (p. 64)
 -  : Stitch Assist (p. 65)
 -  : Movie (p. 68)
- Creative Zone
The user selects exposure, aperture or other settings to achieve special effects.
 - **P** : Program AE (p. 75)
 - **Tv** : Shutter Speed-Priority AE (p. 77)
 - **Av** : Aperture-Priority AE (p. 79)
 - **M** : Manual Exposure (p. 81)
 - **C1** : Custom 1 (p. 109)
 - **C2** : Custom 2 (p. 109)

Main Dial

The main dial is used for selecting certain menus and for displaying images. You can easily and swiftly select, confirm and switch menus.

Turning the Main Dial

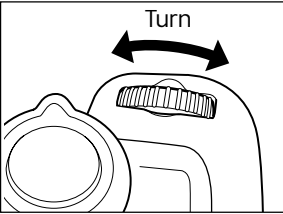

● In Shooting Mode

- Selects Aperture value and shutter speed (p. 77, 79)
- Selects menu settings by pressing the FUNC. button (p. 42)
- Selects exposure compensation and white balance (p. 85, 86)
- Manually sets the focus (p. 106)

● In Replay Mode

- Display the previous and next image (p. 113)

Clicking the Main Dial

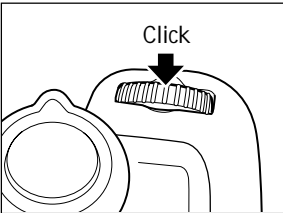

● In Shooting Mode

- Fixes menu items set by pressing the FUNC. button (p. 42)
- Switches between shutter speeds and aperture values in the **M** mode (p. 81)

Display Panel

The display panel shows the camera settings, the remaining image capacity, movie shooting time, battery charge and other information.

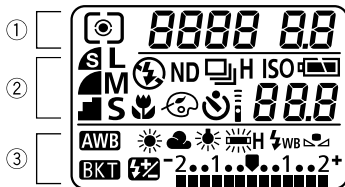

		Evaluative Metering / Spot Metering / Center-Weighted Average Metering	p. 83
①	8888	Shutter Speed / Movie Shooting Time / White Balance / ISO Speed / Photo Effect / Bracket / Resolution Setting Value (for each function setting)	p. 55, 68, 77, 86, 89, 92, 93
	8.8	Aperture Setting	p. 79, 81
②		Compression	p. 55
	L M S	Resolution (Not displayed with RAW images)	p. 55
		Flash On / Flash Off (Not displayed with Auto)	p. 60
	ND	ND filter	p. 110
		Single Shot / Standard Continuous Shooting / High-speed Continuous Shooting	p. 73
	ISO	ISO speed	p. 92
		Battery Charge State	p. 20
		Macro Mode	p. 69
		Photo Effect	p. 89
		Self-Timer / Wireless Controller	p. 70, 174
③	888	Remaining Image Capacity / Message Code / Error Code / <i>int</i> (Intervalometer) / Interval Shooting Remaining Shots	p. 103, 169
		White Balance Settings	p. 86
	BKT	Bracket	p. 93, 95
		Flash Exposure Compensation / Flash Output Adjustment	p. 100
	-2..1..0..1..2+ 	Exposure Compensation Level / AEB Level / Flash Exposure Compensation Level	p. 85, 93, 100



- The diagram above shows all the icons appearing at once. Normally, only the icons applicable to the selected mode and camera state appear.

Preparing the Camera

Charging the Battery Pack

Use the following procedures to charge the battery pack the first time and subsequently when the "Change the battery pack" message displays on the LCD monitor or the low battery icon (⏻) and Lb (Lb) message flash on the Display Panel.

- 1 Turn off the power (p. 29).
 - Make sure that the power/mode indicator is off.

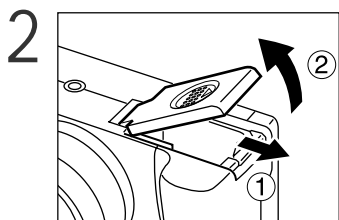

Slide the battery cover in the direction of the arrows.

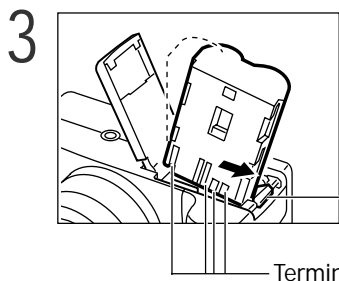

Press the battery lock while inserting the Battery Pack BP-511 and close the battery cover.

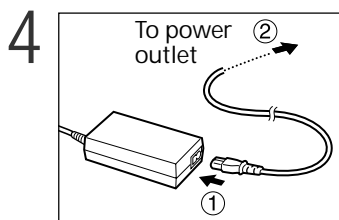

Attach the power cord to the compact power adapter and plug it into power outlet.

5

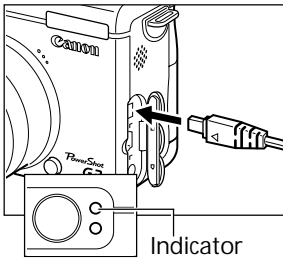

Connect the DC plug of the compact power adapter to the camera's DC IN terminal.

- The indicator beside the viewfinder will blink orange while the battery pack is charging and change to steady orange when it is approximately 90% charged, which is adequate for use. If it is charged for approximately 2 more hours, it will become fully charged and the indicator will switch to green.
- After charging the battery, remove it from the camera when the camera will not be used.



- If the power is turned on while charging, the battery pack will stop charging and the compact power adapter will power the camera.
- This is a lithium ion battery pack so there is no need to completely use or discharge it before recharging. It can be recharged at any time.
- It takes approximately 80 minutes to bring a fully discharged battery pack to a charge state of approximately 90% (adequate charge for use). It takes approximately 2 more hours to charge it fully (based on Canon's testing standard). Charge it within a temperature range of 5 to 40° C (41 to 104° F).
- Charging times will vary according to the surrounding humidity and battery pack charge state.
- Battery Pack BP-512 (optional) can also be used in this camera.

Battery Pack Handling Precautions

- Keep the battery pack and camera terminals (⊕ ⊖ ⊕ ⊖) clean at all times. Dirty terminals may cause a poor contact between the battery pack and camera. Polish the terminals with a tissue or a dry cloth before charging or using the battery pack.
- Do not cover the compact power adapter with anything, such as a tablecloth, cushion or blanket, when it is charging. Heat will build up internally and possibly lead to fire.
- Do not charge batteries other than Battery Pack BP-511 or Battery Pack BP-512 with the supplied equipment. It could damage the camera.
- The battery pack continues to discharge a small amount when left in the camera even with the power turned off. This shortens the battery life. Remove it from the camera, attach the supplied terminal cover and store it at room temperature (30° C / 86° F or less) in a dry place. Charge it before use.

Charging the Battery Pack (continued)

- Do not allow any metal objects such as keyrings to touch the “+” and “-” terminals (Fig. A), as this can damage the battery pack. To carry the battery pack, or store it during periods of disuse, always replace the terminal cover (Fig. B) or place it in the supplied case and store it in a cool, dry place. Recharge it fully before using it again.

Fig.A

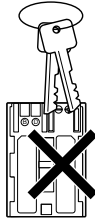
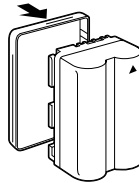

Fig.B



- Even charged battery packs continue to discharge naturally. You are advised to charge the battery on the day of use, or one day before, to ensure a full charge.
- Since storing a fully charged battery pack for long periods of time (about 1 year) can shorten its lifecycle or affect performance, you are recommended to use the battery pack in the camera until the LB symbol displays and to store it at normal temperature (30° C/86° F or less). If you do not use the battery pack for long periods of time, charge it fully and discharge it fully in the camera at least once a year before returning it to storage.
- The camera consumes the battery charge when the power is on even when a function is not being used. To conserve the battery charge, be particularly attentive in turning the camera off.
- Although the battery pack's maximum operating range is 0 to 40° C (32 to 104° F), the optimal range is 10 to 30° C (50 to 86° F). At cold temperatures, such as those experienced when skiing, performance will temporarily decline, reducing the usable time before recharging.
- If the usable time of a battery pack diminishes substantially even when fully charged, it should be replaced.

Installing the Battery Pack

Install Battery Pack BP-511 (supplied) into the camera as follows. Use the Compact Power Adapter CA-560 to power the camera for extended periods (p. 21).

- 1 Turn off the camera (p. 29).
 - Check that the power/mode indicator is not lit.

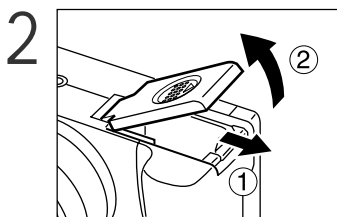

Slide the battery cover in the direction of the arrows.

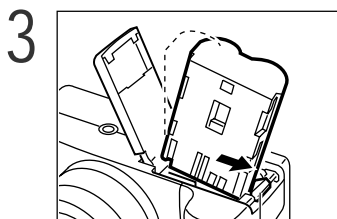

Battery lock

- 3 Press the battery lock while inserting the battery pack all the way in until the lock clicks.
 - To remove the battery pack, release the battery lock.

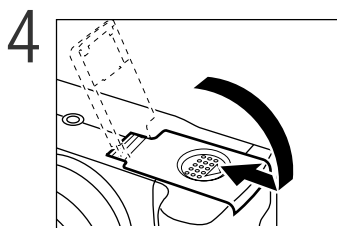

- 4 Slide the battery cover closed.



- Charge the battery pack before using it the first time (p. 16).
- When the upper indicator on the left side of the viewfinder is blinking green, the CF card is being written to, read, erased or transmitted to. Do not turn off the power, open the battery cover or open the CF card slot cover while the camera's indicator blinks green.
- Remove the battery pack when the camera is not in use.

Installing the Battery Pack (continued)

Battery Status Symbols

The following icons indicate the battery status on the display panel. These icons will not appear while the camera is powered with a compact power adapter.

 : Sufficient battery charge

 : Low battery

 : Replace or recharge battery



• See Battery Performance (p. 196).

Using Compact Power Adapter

You should use the Compact Power Adapter CA-560 for long periods of continuous use or for connecting to a computer or printer.

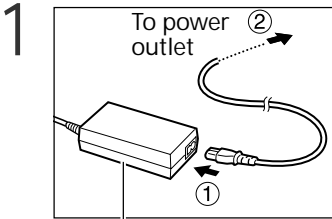

Compact Power Adapter
CA-560

Attach the power cord to the compact power adapter and plug it into a power outlet.

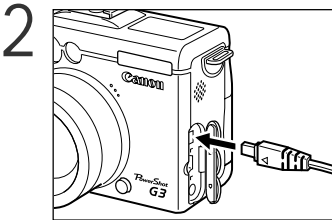

Open the terminal cover and connect the DC plug of the compact power adapter to the camera's DC IN terminal.

- Always disconnect and unplug the compact power adapter after use.



- Always turn the camera's power off before connecting or disconnecting the compact power adapter.
- The battery cannot be charged while the compact power adapter is being used to run the camera (with the power on).
- Do not use Compact Power Adapter CA-560 with any devices other than those for which Battery Pack BP-511 or Battery Pack BP-512 are specified.

Installing a CF Card

- 1 Turn off the camera (p. 29).
 - Check that the power/mode indicator is not lit.

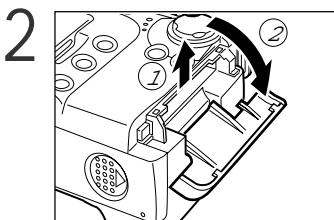

2 Slide the CF card slot cover in the direction of the arrow and lift it open.

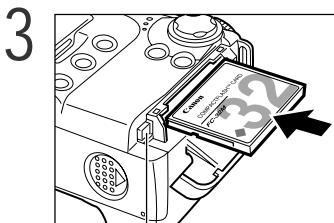

3 Insert the CF card with the label facing up.

- Push the card in until the CF card eject button fully extends.
- To remove the CF card, push the CF card eject button and pull the card out.

CF card Eject Button



- When the indicator on the left side of the viewfinder blinks green, the camera is writing, reading, erasing or transmitting an image to or from the card. Do not perform the following, or image data may be lost or corrupted:
 - Do not shake the camera.
 - Do not turn off the power or open the battery cover or the CF card slot cover.
- Please note that CF cards formatted in or edited with computers, other manufacturer's cameras or application programs may not operate correctly in the camera.



- See CF Cards and Estimated Capacities (p. 197).

CF Card Handling Precautions

- CF cards are high-precision electronic devices. Do not bend, force, or subject them to shocks or vibration.
- Do not attempt to disassemble or alter a CF card.
- Moving a CF card rapidly between temperature extremes may cause condensation to form in the card, leading to potential malfunctions. To avoid condensation formation, place the CF card in a sealed plastic bag before moving it into a different temperature zone and allow it to adjust slowly to the new temperature. If condensation forms on the CF card, put it aside until the water droplets have evaporated completely.
- Place the CF card in the supplied case for storage.
- Do not use or store CF cards in the following types of locations.
 - Locations subject to dust or sand
 - Locations subject to high humidity and high temperatures

Microdrives are a recording medium with a hard disk. Their merits are a large capacity and a low price per megabyte of capacity. However, they can be more susceptible to vibrations and shocks than CF cards, which use durable flash memories. Please be careful, therefore, not to subject the camera to vibrations or shocks when using a microdrive, especially while recording or replaying.

Setting the Date / Time

The Set Date/Time menu will appear the first time the camera power is turned on or whenever the date lithium battery charge is low. Start from Step 5 to set the date and time.

1 Turn on the camera (p. 28).

2 Press the **MENU** button.

- The [📷 (Rec.)] or [▶ (Replay)] menu appears.



📷 (Rec.) Menu.

3 Press the ▶ arrow on the omni selector to select the [🔧 (Set up)] menu.

- Pressing the **JUMP** button also switches between menus.



4 Press the ▲ or ▼ arrow on the omni selector to select [Date/Time] then press the **SET** button.

- The factory default for the date format may differ from that shown here in some regions.

5 Set the date and time.

- Press the ◀ or ▶ arrow on the omni selector to select a field to change.
- Press the ▲ or ▼ arrow on the omni selector to set the values.
- The date can be set up to the year 2030.



6 Press the **SET** button.

- After adjusting the settings, press the **MENU** button to close the menu window.





- The Date/Time cannot be inserted in the actual image even if the Date/Time have been set.
- For printing images with the date on them, refer to page 141.
- Replacing the Date Battery (p. 188).

Setting the Language



1 Turn on the camera (p. 28).

2 Press the **MENU** button.

- The  (Rec.) or  (Replay) menu appears.









 (Rec.) Menu.

3 Press the  arrow on the omni selector to select the [ (Set up)] menu.

- Pressing the **JUMP** button also switches between menus.



4 Press the  or  arrow on the omni selector to select [Language] and press the **SET** button.

5 Press the , ,  or  arrow on the omni selector to select a language.



6 Press the **SET** button.

- After adjusting the settings, press the **MENU** button to close the menu window.



- In replay mode, you can change the language by holding the **SET** button while you press the **JUMP** button, except when a direct print function compatible printer (optional) or a Bubble Jet Printer with the direct print function (optional) is connected or during movie playback.

Attaching the Strap

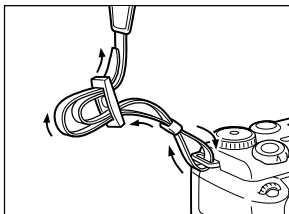

Pass the tip of the strap up through the strap mount on the camera and then through the bottom of the buckle on the strap. Pull the strap tight in the buckle so that it won't slip. Perform the same steps on the other side of the camera.



- Avoid waving the camera about or catching it on other items when suspending it from the strap.

Attaching the Lens Cap

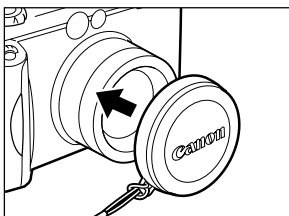

Fit the lens cap over the lens casing so that it covers the entire lens. Always replace the lens cap after use.



- Attach the lens cap cord to the strap.
- Remove the lens cap before turning on the camera's power.

Using the Soft Case (Optional)



The soft case SC-DC10 can be used to carry the camera, CF card and the wireless controller.

- Optional soft case appearance and specifications may vary according to region.

Turning the Power On / Off

The power/mode indicator remains lit while the power of the camera is on. The power/mode indicator indicates the state of the camera as follows.

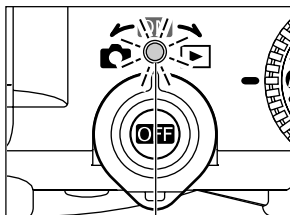

Power/Mode Indicator

Orange: Shooting mode

Green: Replaying mode/Printer connection mode*

Yellow: Computer connection mode*

Off: The power of the camera is off.

* For printer connection mode, see Connecting the camera to a Printer (p. 136).

For computer connection mode, see the Software Starter Guide supplied with the camera.

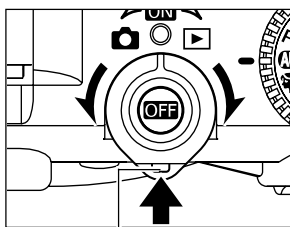

Release button

Mode Lever

Use this lever to turn the power on. To operate the mode lever, press the release button as shown at left. The mode lever will not operate if release button is not pressed.

After the camera is turned on, release the lever. The mode lever returns to its original position (center).

Powering the Camera in Shooting Mode

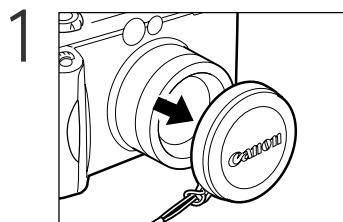

Remove the lens cap.

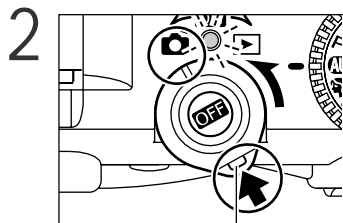

Release button

Turn the mode lever to  (Shooting) while pressing the release button.

- The power/mode indicator lights orange.
- Open the LCD monitor if needed (p. 32).



- **LENS** will appear in the display panel and a warning beep will sound if you turn on the camera with the lens cap on. If this occurs, remove the lens cap and turn the camera off and back on.
- Be careful not to touch the lens when shooting. Please also refrain from forcing the lens with fingers or other objects. It could lead to malfunctions or damage the camera. If this occurs, turn the camera off and back on.

Powering the Camera in Replay Mode

1

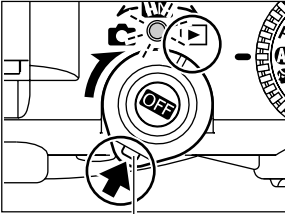

Release button

Open the LCD monitor and turn the mode lever to  (Replay) while pressing the release button.

- The power/mode indicator lights green.

Turning the Power Off

1

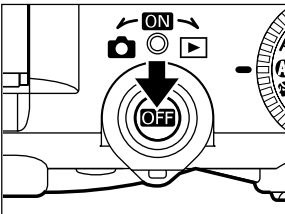

Press the **OFF** button.

- The power goes off.

Turning the Power On / Off (continued)



- You will hear a startup sound and see the startup image when the power comes on. (To change the startup sound and image, see below and pages 46 and 166.)
- The startup image does not appear when the LCD monitor is off or the **A/V OUT** terminal is connected to a TV.

Turning on the camera without the startup sound and image

Press and hold the  button, then turn on the power.

Power-saving Function

The camera is equipped with a power-saving function. If [Auto Power Down] is set to [On], the power goes off according to the following conditions.



Shooting Mode: Powers down approximately three minutes after the last time a camera control is accessed. The LCD monitor will shut off approximately three minutes after the last time a camera control is accessed even if the power-saving function is turned off.

Replaying Mode: Powers down approximately five minutes after the last time a camera control is accessed.

Printer Connection Mode: Powers down approximately five minutes after the last time a camera control is accessed on the camera or something is printed on the printer.

PC Connection Mode: Displays a warning message on the computer screen approximately 5 minutes after a control is last accessed. The camera will power down if no controls are used after 1 additional minute.



It will not activate when the camera's communication setting is set to [PTP] (p. 157).

- Turning the mode lever toward  or  will restore power when the camera shuts down with the power-saving function.
- Please note that the camera continues to consume a minimal amount of power even when the power-saving function shuts it down.
- The power-saving function is disabled while a slide show plays on the camera (p. 124).
- You can turn off the power-saving function in the [ (Set up)] menu (p. 162).

Switching between Shooting and Replaying

You can quickly switch between Shooting mode and Replaying mode. This is convenient when you wish to shoot again after checking or deleting an image immediately after it is shot.

● Shooting Mode

- 1 Open the LCD monitor and turn the mode lever to  (Replay) while pressing the release button (p. 29).
 - The camera switches to Replaying mode. In this case, the lens does not retract. (If the mode lever is turned to  (Replay) again, the lens retracts.)
 - To return to Shooting mode, turn the mode lever to  (Shooting) while pressing the release button or press the shutter button halfway.

● Replaying Mode

- 1 Remove the lens cap.
-
- 2 Press the shutter button halfway or turn the mode lever to  (Shooting) while pressing the release button (p. 28).
 - The camera switches to shooting mode.

Using the LCD Monitor

The LCD monitor can be used to confirm an image during shooting, to replay recorded images or to adjust menu settings. It can be opened to the following range of positions.

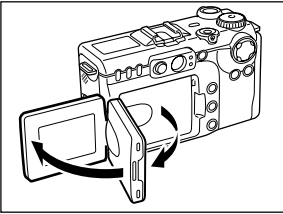

- Opened from left to right 180 degrees. It locks temporarily at 90 degrees.

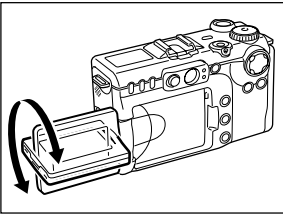

- Tilted forward 180 degrees toward the lens or backward 90 degrees.

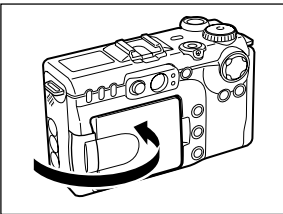

- The LCD monitor will automatically turn off when it clicks shut against the camera body. For protection, always close the LCD monitor after use.



- Prevent the DC cable from touching the LCD monitor when the camera is connected to a compact power adapter.

The LCD monitor can also be positioned as below.

1

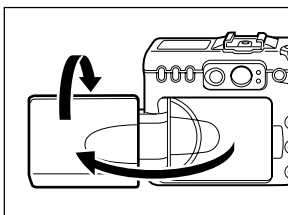

Open the LCD monitor left 180 degrees and tilt it 180 degrees toward the lens.

- In this position, icons and messages do not appear on the LCD monitor.
- The image shown on the LCD monitor is automatically flipped and reversed so that it appears correctly from in front of the lens.

2

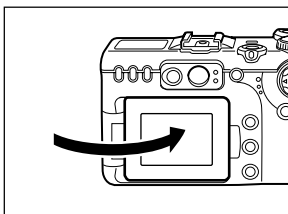

Fold the LCD monitor back against the camera body.

- Fold it until it clicks into place against the camera body. If it is not fully closed, the image will appear reversed and icons and messages will not display.
- Icons and messages will appear and images will show properly (not reversed) when the LCD monitor is folded right against the camera until it clicks.

Switching between Display Modes

Pressing the **DISPLAY** button switches the LCD monitor display mode.

● Shooting Mode

- Pressing the **DISPLAY** button cycles the LCD monitor to the next mode each time the button is pressed.



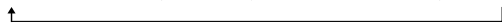



On (No Information) → On (Information View)* → Off



*Depending on the LCD monitor's position, the information view may not display.

Using the LCD Monitor (continued)



- You can also set the LCD monitor display settings in the shooting mode while an image is being reviewed right after being taken by first pressing the **SET** button and then the **DISPLAY** button.
- The display mode is memorized when the camera is turned off. It assumes the last mode when it is turned on again. When the LCD monitor is used for shooting and the low battery icon  appears, however, the LCD monitor may not automatically turn on the next time the camera is started.
- When the LCD monitor is set to On (No Information) or Off, shooting information appears for approximately 6 seconds when you take any of the following actions.
 - The power is turned on.
 - The     button is pressed.
 - The focus is set with the manual focus.
 - The shutter speed or the aperture value is changed with the main dial.
 - The shooting mode is changed.
- Setting the mode dial to  or  turns on the LCD monitor regardless of whether it is set to on or off.



- The camera shake warning icon  will appear on the LCD monitor in low light conditions while the camera is preparing to shoot. When this icon appears, set the flash to On or Auto, or fix the camera to a tripod to shoot.

● Replaying Mode

- Pressing the **DISPLAY** button cycles the information view mode each time the button is pressed.

Single Replay (p. 113): Simple Display → Detailed Display → No Display

Index Replay (p. 115): Simple Display ↔ No Display

Using the LCD Monitor (continued)

● Replaying Mode



In simple display mode, the following information appears.

	Compression Settings	p. 55
L M1 M2 S	Resolution Settings (still image)	p. 55
RAW	File Format	p. 58
	Sound annotation (wave file)	p. 122
AVI	Movie	p. 117
	Protection Status	p. 128

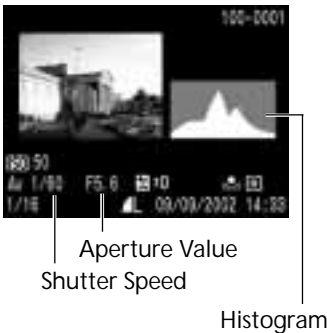

In detailed display mode, the following information also appears.

ISO 50 100 200 400	ISO Speed	p. 92
	Photo Effect	p. 89
	Shooting Mode	p. 13
320 160	Resolution Settings (Movie)	p. 55
	Exposure level	p. 85
	Flash Exposure Compensation	p. 100
	White Balance	p. 86
	Light Metering Mode	p. 83
	Macro Mode	p. 69
MF	Manual Focus	p. 105, 106

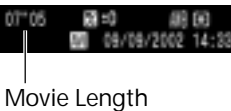

- In addition to the above, the shutter speed, aperture setting, movie length, histogram and overexposure warning appear.

The following information may also appear with some image files.

	An audio file other than a wave file, or a file with an unrecognized format, is attached.
	JPEG file with format not conforming to Design rule for Camera File System Standards.
	File with unrecognized format.



- Please note that image information recorded by this camera may not display correctly on other cameras and image information recorded by other cameras may not display correctly on this camera.

About the Histogram

The histogram is a graph that allows you to judge the brightness of the recorded image. The greater the bias toward the left in the graph, the darker the image. The greater the bias toward the right, the brighter the image. If the image is dark, adjust the exposure compensation to a positive number. Similarly, adjust the exposure compensation to a negative number if the image is bright (p. 85).

Histogram Examples



Dark Image



Balanced Image

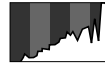

Bright Image

Overexposure Warning

In detailed display mode, overexposed portions of the image blink.

Notice Concerning Shooting

When using this camera to shoot scenes containing extremely bright subjects, a vertical, red bar of light may appear on the LCD monitor. This is a normal occurrence in devices containing CCDs and does not constitute a malfunction. This red bar of light will not be recorded when shooting still photos, but it will be recorded when shooting movies.

Using the Optical Viewfinder to Shoot

Setting the LCD monitor to Off (p. 33) and using the optical viewfinder can help conserve power while shooting.

- You can adjust the viewfinder with the diopter adjustment dial to adapt to your vision so that the subject appears in crisp focus. Adjustments of -3 to $+1\text{m}^{-1}$ (diopter equivalent) can be made.
- The viewfinder has a field of vision of approximately 83% of the actual shooting image.

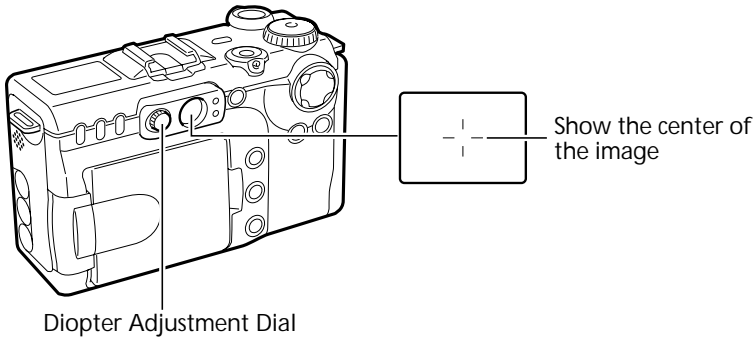

Image Seen in Viewfinder vs. Recorded Image

Please note that the actual image may differ from the image seen in the optical viewfinder due to the physical separation between the viewfinder and lens. This is called the parallax phenomenon and is more noticeable the closer the subject is to the lens. In some cases, portions of images shot up close that appear in the viewfinder will not appear in the recorded image. You are recommended to use the LCD monitor to shoot images up close.

Shooting with an Off-Center AF Frame Selected

When setting the AF frame to the desired position to shoot an image, please use the LCD monitor (See Selecting an AF Frame, p. 82).

Pressing the Shutter Button

The shutter button features a two-stage action.

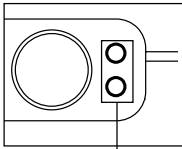
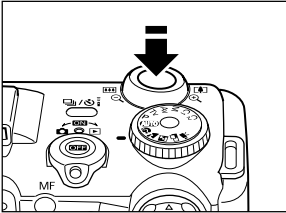

Indicators



AF Frame

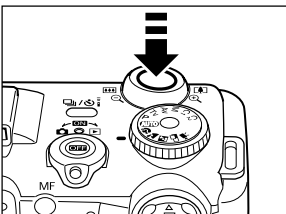

● Pressing Halfway

Pressing halfway automatically sets the exposure, focus and white balance.

- The indicators light or blink as follows.

Upper indicator

- Green: Metering complete (two beeps sound)
- Orange: Flash will fire
- Blinking Orange: Camera shake warning / Insufficient exposure

Lower indicator

- Yellow: Macro mode/Manual focus mode
- Blinking Yellow: Focusing difficulty* (single beep sounds)

* Use the focus lock, or focus manually, to shoot when the indicator blinks yellow (p. 106).

- The AF frame appears as follows when the LCD monitor is on.
 - Green: Metering complete
 - Yellow: Focusing difficulty

● Pressing Fully

Pressing fully releases the shutter.

- The upper indicator blinks green while the image is recording onto the CF card.
- You will hear the shutter sound when the shot is complete. Do not move the camera until you hear this sound.

Pressing the Shutter Button (continued)



- If the orange or yellow indicator blinks while you press halfway, you can still press fully to take the shot.
- Images are first saved into the camera's internal memory before being recorded onto the CF card, allowing the next images to be taken immediately as long as sufficient space is available in the internal memory.
- The beep and shutter sound can be set On / Off in the Set up menu (p. 162, 163).
- When the shutter sound is set to Off, but the beep is set to On, one beep will sound when the shutter button is fully pressed.
- There is no shutter sound in movie mode.

AF-assist Beam



- The AF-assist beam will sometimes emit when the shutter button is pressed halfway to assist focusing in certain conditions, i.e. dark conditions.
 - The AF-assist beam can be turned off (p. 159).
- If animals are your subject, turn off the beam when shooting in the dark to avoid startling them (this may however, make it more difficult for the camera to focus.).

Using the Zoom (Focal Length)

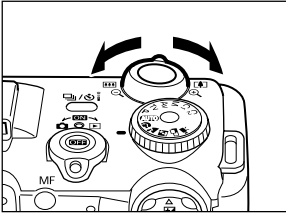
The zoom can be adjusted from 35 to 140 mm (equivalent to 35 mm film format).



Telephoto / Wide Angle

- Press the zoom lever toward  to zoom in (telephoto).
- Press the zoom lever toward  to zoom out (wide angle).



Digital Zoom

- An image already zoomed with the optical zoom lens can be further zoomed digitally up to an approximate factor of 14 for shooting (p. 72).

.....



- The digital zoom cannot be used with certain Shooting modes (p. 204).

.....



- The more the image is zoomed digitally, the coarser its image quality becomes.

Selecting Menus and Settings

Menus are used to adjust shooting, replaying, date / time and beep sound settings. Menus can be displayed by either pressing the **FUNC.** button or the **MENU** button. Watch the LCD monitor while performing the following procedures.

Selecting Settings by Pressing the **FUNC.** Button (Only in Shooting Mode)

1 Turn the mode lever to  (Shooting).

2 Press the **DISPLAY** button to turn on the LCD monitor.
• Some functions can also be operated from the display panel.

3 Press the **FUNC.** button.
• Icons of the selectable settings appear on the left side of the LCD monitor.
• The current settings icons appear.



4 Select a menu item using the **▲** or **▼** arrow on the omni selector.

5 Select setting contents by using the **◀** or **▶** arrow on the omni selector or by turning the main dial.

- Some menu items can only be selected after clicking the main dial or pressing the ***** button and displaying the next menu. Click the main dial or press the ***** button again to confirm the setting.



6 Press the **FUNC.** button, the **SET** button or click the main dial.
• The menu closes.
• Images can be shot immediately with the selected settings after Step 5 by pressing the shutter button.



- In Steps 5 and 6, you can easily select settings using the main dial.

Selecting Settings by Pressing the **MENU** Button

1

Press the **MENU** button.

- In Shooting mode, the **[REC.]** menu appears. In Replaying mode, the **[REPLAY]** menu appears.

2

Press the ◀ or ▶ arrow on the omni selector to switch between menu tabs.

- The menu switches as follows:
[REC.] or **[REPLAY]** ↔ **[SET UP]** ↔ **[MY CAMERA]**
- Pressing the **JUMP** button or the zoom lever also switches between the menu tabs.



3

Press the ▲ or ▼ arrow on the omni selector to select a menu item.



4

Press the ◀ or ▶ arrow on the omni selector to select setting contents .

- Press the **SET** button for items followed by an ellipsis (...) and then select a setting. Press the **SET** button again to confirm the setting.



5

Press the **MENU** button.

- The menu closes.
- In Shooting mode, the menu can be closed by pressing the shutter button halfway. (In Replaying mode, the menu closes when the shutter button is pressed halfway and the camera switches to shooting mode.)



- Settings cannot be selected with the main dial.

Selecting Menus and Settings (continued)

Menu Settings and Factory Defaults

This chart shows the options for each menu and the default settings.

Menu Items Selectable with the **FUNC.** Button























Menu Item	Available Settings	Reference Page
ISO Speed	AUTO / 50 / 100 / 200 / 400	p. 92
Photo Effect	* / / / / / / / /	p. 89
Bracket	* / /	p. 93, 95
Flash Exposure/Flash Output	-2 to +2 / 1 ~ 3 (FULL)	p. 100, 101
Resolution, File Format, Compression	(Still picture) L* / M1 / M2 / S / RAW (Movie) * / (Compression) / * /	p. 55, 58

Menu Items Selectable with the **MENU** Button



Menu Item	Available Settings	Reference Page
Flash Sync	1st-curtain*, 2nd-curtain	p. 102
Slow Synchro	On/Off*	p. 61
Flash Adjust	Auto*/ Manual	p. 100
Red-eye	On*/ Off	p. 61
Cont. Shooting	* (Normal) / (High Speed)	p. 73
Self-timer	10 sec.* / 2 sec.	p. 70
Wireless Delay	0 sec. / 2 sec.* / 10 sec.	p. 174
Spot AE Point	Center* / AF Point	p. 83
ND Filter	On / Off*	p. 110
MF-Point Zoom	On*/ Off	p. 106
AF Mode	Continuous*/ Single	p. 108
AF-assist Beam	On*/ Off	p. 159
Digital Zoom	On / Off*	p. 72
Review	Off / 2* to 10 sec.	p. 54
Intervalometer	Automatically shoots images at a set time interval	p. 103
Save Settings	Saves customized settings	p. 109



Rec.
Menu
(Red)

	Menu Item	Available Settings	Reference Page
 Replay Menu (Blue)	Protect	Turns image protection on and off	p. 128
	Rotate	Rotates the image in the display	p. 121
	Erase all	Erases all images on the CF card	p. 130
	Slide Show	Replays selected images in a slide show	p. 124
	Print Order	Sets the print settings	p. 145
	Transfer Order	Sets the transfer settings	p. 152
 Set up Menu (Yellow)	Beep	On* / Off	p. 162
	LCD Brightness	 * / 	p. 162
	Auto Power Down	On* / Off	p. 162
	Date/Time	Sets the date and time	p. 24
	Format	Formats the CF card	p. 131
	Shutter Volume	Off / 1 / 2* / 3 / 4 / 5	p. 163
	Playback Vol.	Off / 1 / 2* / 3 / 4 / 5	p. 163
	Start-up Vol.	Off / 1 / 2* / 3 / 4 / 5	p. 163
	Operation Vol.	Off / 1 / 2* / 3 / 4 / 5	p. 164
	Selftimer Vol.	Off / 1 / 2* / 3 / 4 / 5	p. 164
	File No. Reset	On / Off*	p. 112
	Auto Rotate	On* / Off	p. 111
	Distance Units	m/cm* / ft/in	p. 164
	Language	English* / Deutsch / Français / Nederlands / Dansk / Suomi / Italiano / Norsk / Svenska / Español / Chinese / Japanese	p. 26
	Video System	NTSC / PAL	p. 165
	Communication	Normal* / PTP	p. 157
 My Camera Menu (Purple)	Theme	 / 1 * /  / 	p. 46, 166
	Start-up Image	 / 1 * /  / 	p. 46, 166
	Start-up Sound	 / 1 * /  / 	p. 46, 166
	Operation Sound	 / 1 * /  / 	p. 46, 166
	Selftimer Sound	 / 1 * /  / 	p. 46, 167
	Shutter Sound	 / 1 * /  / 	p. 46, 167

* Default values. Default languages and video system settings vary between regions.

- Some menu items are not available in certain shooting modes.
- You can apply a desired image and sound to  and  in the My Camera menu. For details, see Registering the My Camera Settings (p. 48) or the Software Starter Guide.
- The default of all the settings changed by the menu and button operations except for [Date/Time], [Language] and [Video System] can be restored all at once (p. 168).

Customizing the Camera (My Camera Settings)

My Camera allows you to customize the start-up image and start-up, shutter, operation and self-timer sounds. Each menu item has three choices.

e.g. Start-up image

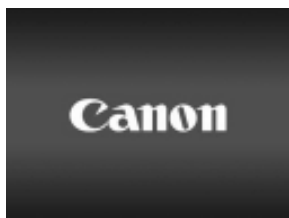

[1]

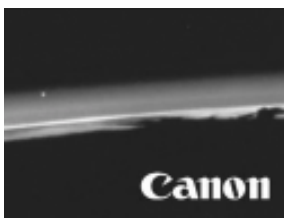

[2]

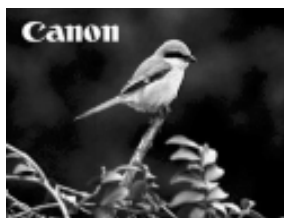

[3]

As default settings, My Camera setting [2] has a science fiction theme and My Camera settings [3] has an animal (bird) theme.

Changing My Camera Settings

- 1 Turn on the camera (p. 28).
- 2 Press the **MENU** button.
 - The [Rec.] or [Replay] menu appears.
- 3 Select the [My Camera] menu using the ► arrow on the omni selector.
 - Pressing the **JUMP** button also switches between the menu tabs.
- 4 Select a menu item using the ▲ or ▼ arrow on the omni selector.



5 Select setting content using the ◀ or ▶ arrow on the omni selector.



6 Press the **MENU** button.

- Pressing the **MENU** button closes the menu and makes the settings take effect.
- In Shooting mode, the menu can be closed by pressing the shutter button halfway. (In Replaying mode, the menu closes when the shutter button is pressed halfway and the camera switches to shooting mode.)



- If you select [Theme] in Step 5, you can select a consistent theme for each of the My Camera Settings.
- If [Beep] in the [SETUP] (Set up) menu is set to [On], the beep sounds even if each sound item such as [Start-up Sound], [Shutter Sound], [Operation Sound] and [Selftimer Sound] in the [MENU] (My Camera) menu is set to [OFF] (Off) (p. 162).

Registering the My Camera Settings

You can easily add images and newly recorded sounds saved on the CF card as My Camera settings to the camera's [L2] and [L3] menu items. You can also use the supplied software to upload your computer's images and sounds to the camera.

The following menu items can be saved to the camera.

- Start-up Image
- Start-up Sound
- Operation Sound
- Selftimer Sound
- Shutter Sound

Registering CF Card Images and Sounds



- 1 Turn the mode lever to  (Replay).
 - The camera switches to Replaying mode.

- 2 Press the **MENU** button.
 - The [ (Replay)] menu appears.



- 3 Select the [L2] (My Camera) menu using the  arrow on the omni selector.
 - Pressing the **JUMP** button also switches between the menu tabs.



- 4 Select the menu item you wish to register using the  or  arrow on the omni selector.

5 Select [F2] or [F3] using the ◀ or ▶ arrow on the omni selector.

- [DISPLAY]  appears.

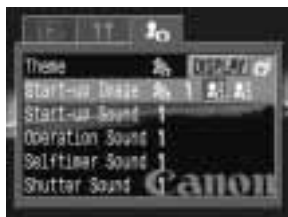

6 Press the **DISPLAY** button.

- An image appears.

[Start-up Image] → Step 7a, 8a

[Start-up Sound], [Shutter Sound], [Selftimer Sound] → Step 7b, 8b



7a Select the image you wish to register using the ◀ or ▶ arrow or on the omni selector.





8a Press the **SET** button.

7b Select [ (Record)] using the ◀ or ▶ arrow on the omni selector.

- Recording starts.
- Recording stops when the set amount of time has passed.

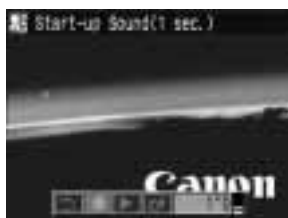
Start-up Sound: 1 second, Operation Sound: 0.3 second, Selftimer Sound: 2 seconds, Shutter Sound: 0.3 second.



8b Select [ (Register)] using the ◀ or ▶ arrow or on the omni selector.

9 Select [OK] using the ◀ or ▶ arrow or on the omni selector and press the **SET** button.



Registering the My Camera Settings (continued)



- Movie and RAW image sounds recorded with the Sound Annotation function (p. 122) cannot be registered.
- When you register new My Camera settings, the previously registered settings are erased.

File Format of My Camera Settings

My Camera settings should conform to the below file formats. However, CF card images shot with this camera can be registered as My Camera settings regardless of the below formats.

● Start-up Image

- Recording image format JPEG (Base line JPEG)
- Sampling rate 4:2:0 or 4:2:2
- Image size 320 x 240 pixels
- File capacity 20 KB or less

● Start-up Sound, Operation Sound, Selftimer Sound and Shutter Sound

- Recording format WAVE (monaural)
- Standardizing bit 8 bit
- Sampling frequency 11.025 kHz and 8.000 kHz
- Recording time

	11.025 kHz	8.000 kHz
Start-up Sound	1.0 sec. or less	1.2 sec. or less
Operation Sound	0.3 sec. or less	0.4 sec. or less
Selftimer Sound	2.0 sec. or less	2.0 sec. or less
Shutter Sound	0.3 sec. or less	0.4 sec. or less

Any file format other than those described above cannot be used with this camera.

An example of this function is to record "Say cheese" as the Selftimer sounds so the camera will replay this sound two seconds before the photo is taken.

See the supplied *Software Starter Guide* for more information on creating and adding My Camera Settings files.

Shooting - Letting the Camera Select Settings

See Functions Available in Each Shooting Mode (p. 204) at the end of this manual to find out which settings can be changed in which shooting modes.

AUTO Auto Mode

In this mode, all you have to do is press the shutter button and let the camera do everything else.

1 Check that the camera is in Shooting mode (p. 28).

2 Turn the mode dial to **AUTO**.

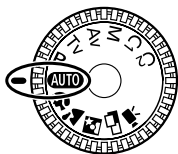

3 Aim the camera at the subject.

4 Use the zoom lever to achieve the desired composition (relative subject size in the viewfinder).

5 Press the shutter button halfway (p. 39).

- Two beeps will sound when the camera has finished metering, and the indicator beside the viewfinder will light green or orange. If the LCD monitor is on, the AF frame will appear green.
- The shutter speed and aperture value are automatically determined and show on the display panel. They also show on the LCD monitor if it is on.
- The yellow indicator will blink and the beep will sound one time if the subject is difficult to focus on. The AF frame will also appear yellow.

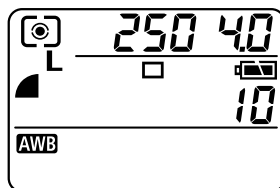

AF Frame

-
- 6 Press the shutter button all the way (p. 39).
- You will hear the sound of the shutter when the shutter activates.
 - The picture appears for two seconds on the LCD monitor, if it is on.



- Functions Available in Each Shooting Mode (p. 204)
- With the Review function, you can change the length of time images show on the LCD monitor after shooting, or set it so they do not show at all (p. 54).

Reviewing an Image Right after Shooting

Reviewing the Image

After a photo is taken, the image displays on the LCD monitor for two seconds (See p. 54 to change the display time). There are two ways to display the image for longer period.

● Keeping the Shutter Button Pressed

The image continues to appear on the LCD monitor as long as you keep the shutter button fully depressed.

● Pressing the **SET** button while the image is displayed

If you press the **SET** button while the image is displayed on the LCD monitor, it will continue to display even after the shutter button is released. Press the shutter button halfway again to stop displaying it.

.....



- You can perform the following while images are displayed.
 - Erasing Images Individually (p. 9, 129)
 - Displaying Images in detailed display mode (p. 34)
 - Magnifying Images (p. 114)
 - Changing the Recording Format (p. 53)
 - Attaching Sound Annotations (p. 122)

Changing the Recording Format Right after Shooting

By following the below instructions, you can save images shot in the JPEG format in the RAW format (p. 58) right after shooting if the camera is set to **P**, **Tv**, **Av**, **M**, **C1** or **C2***. You can easily process images saved in the RAW format using a computer to edit the resolution, photo effect and white balance without any loss of quality.

* The JPEG format image will not be saved.

1 Right after shooting, press the **FUNC.** button while the image is displayed on the LCD monitor.

2 Select [OK] using the ◀ or ▶ arrow on the omni selector and press the **SET** button.

- The image is recorded in the RAW format.
- When you press the shutter button halfway, the camera returns to the shooting screen.





- The above operations cannot be performed if the image was shot with the digital zoom or when **RAW** is already selected as the recording format.

Changing the Image Display Duration

The length of time images are displayed after a photo has been taken can be changed anywhere from 2 seconds to 10 seconds or turned off.

- 1 In the [ (Rec.)] menu, select [Review].
 - See Selecting Menus and Settings (p. 42).

- 2 Select a Review setting and press the **MENU** button.



- With the [Off] option, the image will not automatically display.
- With the [2 sec.] to [10 sec.] options, the image will appear for the time selected even if the shutter button is released.
- You can continue to display the image as long as the shutter button is held down regardless of the Review setting.
- Another picture can be taken even while the last is displayed.





Changing the Resolution and Compression

You can change the resolution and compression (excluding movies) settings to suit the purpose of the image you are about to shoot. To record the CCD output without compression, select the RAW file format (p. 58).

Resolution			Purpose
L (Large)	2272 x 1704 pixels	High ↑ ↓ Low	• Print large prints
M1 (Medium 1)	1600 x 1200 pixels		• Print on small labels
M2 (Medium 2)	1024 x 768 pixels		• Send images as e-mail attachments
S (Small)	640 x 480 pixels		• Shoot more images

Compression			Purpose
	Superfine	High Quality ↑ ↓ Normal	• Shoot higher quality images
	Fine		• Shoot normal quality images
	Normal		• Shoot more images

- Movies can be shot with the following resolution.

Resolution	
	320 x 240 pixels
	160 x 120 pixels

- 1 Press the **DISPLAY** button to turn the LCD monitor on.
 - Settings can be changed even if the LCD monitor is off. However, the compression cannot be changed.

- 2 Press the **FUNC.** button.

- 3 Select  **L*** (LCD monitor) or **L*** (Display Panel) using the **▲** or **▼** arrow on the omni selector.

* The current setting is displayed.



Changing the Resolution and Compression (continued)

- 4 Select the resolution you wish to set using the main dial or the ◀ or ▶ arrow on the omni selector.

Resolution (Excluding )



Number of recordable images
(Only displayed when the resolution,
compression or file format is selected)

- 5 Press the * ·  button.

- 6 Select the compression you wish to set using the main dial or the ◀ or ▶ arrow on the omni selector.

- You can shoot the image right after selecting settings by pressing the shutter button. This screen will appear again, once the image is shot.

Compression



- 7 Press the **SET** button, the **FUNC.** button or click the main dial.
- The selected compression and resolution appear on the LCD monitor and on the display panel.

- 8 Shoot the image.



- Some settings are not available with certain Shooting modes. Please refer to Functions Available in Each Shooting Mode (p. 204).
- Volume of an Image (approximate) (p. 197)
- Types of CF cards and resolution (p. 197)
- The resolution and compression settings are affected by the shooting mode selection as follows (only the resolution in **P** mode).

Initial Shooting Mode	Next Shooting Mode	Resolution and Compression after Change
AUTO C1 C2	AUTO P Tv Av M C1 C2	Settings change to those of the next mode
		Settings do not change
	AUTO P Tv Av M C1 C2	Settings change to those of the next mode
P Tv Av M	P Tv Av M	Settings do not change
	AUTO C1 C2	Settings change to those of the next mode

Changing the File Format

The recording file format can be switched to the RAW format before shooting the image.

With the standard JPEG file format, the camera processes images after capturing them to produce optimal results. The JPEG format compresses images so that more can be stored on a single CF card. However, the compression is irreversible, meaning that the original image data cannot be recovered after processing. In contrast, the RAW format records the image data as captured by the camera's CCD without further processing. RAW images are compressed, but the compression is reversible* so that a high-quality image can be obtained from the decompressed file without any loss of image quality. In addition, although a RAW file is larger than an equivalent JPEG file, it is still only approximately one-quarter the size* of an uncompressed RGB TIFF format file, making it relatively compact.

With standard uncompressed file formats, such as RGB TIFF, images are processed in the camera and require further processing by retouching software to adjust the image parameters, which reduces image quality. With the RAW format, however, the original data can be used in special software** to adjust the image parameters (white balance, contrast, sharpness and saturation) making it possible to maintain the image quality while making changes. The resolution (2272 x 1704) and compression settings cannot be adjusted for these images.

* As measured by Canon's testing standard.

** The bundled software can be used to open or adjust the parameters of images recorded in the RAW file format. Please consult the *Software Starter Guide* for details.

1 Turn the mode dial to **P**, **Tv**, **Av**, **M**, **C1** or **C2**.

2 Press the **DISPLAY** button to turn the LCD monitor on.

3 Press the **FUNC.** button.

4 Select **L*** (LCD monitor) OR **L*** (Display Panel) using the **▲** or **▼** arrow on the omni selector.

* The current setting is displayed.



5 Select **RAW** (LCD monitor) or **r** (r) (Display panel) using the main dial or the ◀ or ▶ arrow on the omni selector.

- You can shoot the image right after selecting settings by pressing the shutter button. The previous screen will appear again, once the image is shot.

6 Press the **SET** button, the **FUNC.** button or click the main dial.

- **RAW** appears on the LCD monitor and on the display panel.





7 Shoot the image.



- Images shot in the JPEG format can also be changed to the RAW format while they are displayed right after shooting (p. 53).

⚡ Using the Flash

Use the flash according to the guidelines below.

 *	Red-eye reduction, Auto	The flash fires automatically as required by the lighting level, and the red-eye reduction lamp fires each time the main flash fires
 *	Auto	The flash fires automatically as required by the lighting level.
 *	Red-eye reduction, Flash on	The red-eye reduction lamp and the flash always fire.
 *	Flash on	The flash always fires.
 *	Flash off	The flash does not fire.

* No icon appears in the display panel.

- For information on the external flash, see page 177.

1 Press the  button to switch between flash modes.

- The selected flash mode appears on the display panel. It also appears on the LCD monitor if it is on.
- You can switch between settings by pressing the  button.

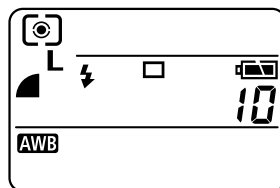

When the red-eye reduction function is on (p. 61)

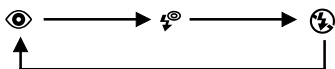

When the red-eye reduction function is off (p. 61)

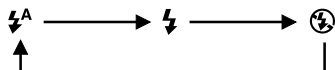

2 Shoot the image.

- The flash will fire if the indicator beside the viewfinder lights orange when the shutter button is pressed halfway.
- Shooting procedures are the same as for the **AUTO** mode (p. 51).



- Some settings are not available with certain Shooting modes. Please refer to Functions Available in Each Shooting Mode (p. 204).

Setting the Red-eye Reduction Function

The red-eye reduction lamp fires when the flash is used in dark areas. This prevents light from reflecting back from the eyes and making them appear red.

1 In the [📷 (Rec)] menu, set [Red-eye] to [On].



- When shooting with the red-eye reduction function, the subjects must look right at the red-eye reduction lamp for this mode to be effective. Try asking them to look directly at the lamp. Even better results can be obtained by shooting with the lens set to a wide angle, increasing the lighting in indoor settings or approaching closer to the subject.

Setting the Slow Synchro

You can shoot images using the flash with a slow shutter speed. This helps avoid dark backgrounds when shooting night scenes or with indoors lighting conditions.

1 In the [📷 (Rec.)] menu, set [Slow Synchro] to [On].

⚡ Using the Flash (continued)



- When shooting with a high ISO sensitivity and using the built-in flash, there is more of a chance of overexposure the closer you are to the subject.



- When shooting with [Slow Synchro] set to [On], we recommend the use of a tripod to prevent camera shake.
- Some settings are not available with certain Shooting modes. Please refer to Functions Available in Each Shooting Mode (p. 204).
- The flash fires twice. A pre-flash will fire and will be followed by the main flash. The pre-flash is used by the camera to obtain the subject's exposure data so that the main flash can be set to the optimal intensity for the shot.
- The fastest shutter speed for flash synchronization is 1/250 second. The camera automatically resets the shutter speed to 1/250 second if a faster speed is selected.
- The built-in flash may take up to approximately 10 seconds to charge in some cases. Actual times will vary according to usage and the battery charge.
- The flash fires with automatic adjustments when [Flash Adjust] is set to [Auto] in the [Rec.] menu. When shooting in **M** mode, or with [Flash Adjust] set to [Manual], the flash fires fully or with the manually set adjustments.
- The flash exposure and the Flash Output can be changed (p. 100).
- The flash setting is saved when the camera is turned off in the **P**, **Tv**, **Av** and **M** shooting modes.
- When shooting with the flash, light may reflect off dust particles or insects in the air and appear as white dots or white asterisks on the image. This occurs more frequently in the following conditions:
 - When shooting at the wide-angle end.
 - When shooting with a high aperture value in the aperture-priority AE mode. This is a phenomenon that occurs with digital cameras and does not constitute a malfunction.





Portrait Mode

Use this mode when you want the subject to appear sharp and the background to blur.

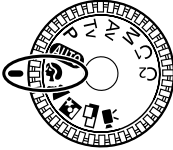

1



Turn the mode dial to .

- Shooting procedures are the same as for the **AUTO** Mode (p. 51).



- Functions Available in Each Shooting Mode (p. 204)
- To best achieve the effect of the background gradually fading, compose the image so that the upper half of the subject's body fills most of the viewfinder or LCD monitor.
- The background gets increasingly indistinct the more you adjust the focal length toward telephoto.



Landscape Mode

Use this mode to shoot expansive landscape scenes.



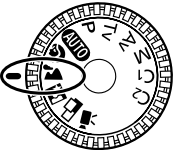

1



Turn the mode dial to .

- Shooting procedures are the same as for the **AUTO** Mode (p. 51).



- Functions Available in Each Shooting Mode (p. 204)
- Since a slow shutter speed is often selected in  mode, use a tripod to shoot if the  (camera shake warning) icon appears on the LCD monitor.

Night Scene Mode

Use this mode to capture human subjects against the backdrop of an evening sky or night scene. The people are illuminated with light from the flash while the backdrop is captured at a slow shutter speed so that both appear correctly exposed.

1

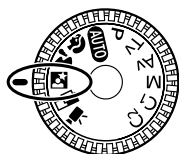



Turn the mode dial to .

- Shooting procedures are the same as for the **AUTO** mode (p. 51).



- Always use a tripod to prevent camera shake in this mode.



- Functions Available in Each Shooting Mode (p. 204)
- Warn people to stay still for a few seconds after the flash fires because of the slow shutter speed.
- Using the  mode in daylight will produce an effect similar to that of the **AUTO** mode.
- With the  mode, the slow synchro function automatically turns on (p. 61).



Stitch Assist Mode

Use this mode to shoot a series of overlapping frames for merging (stitching) into a large panoramic image using a computer.

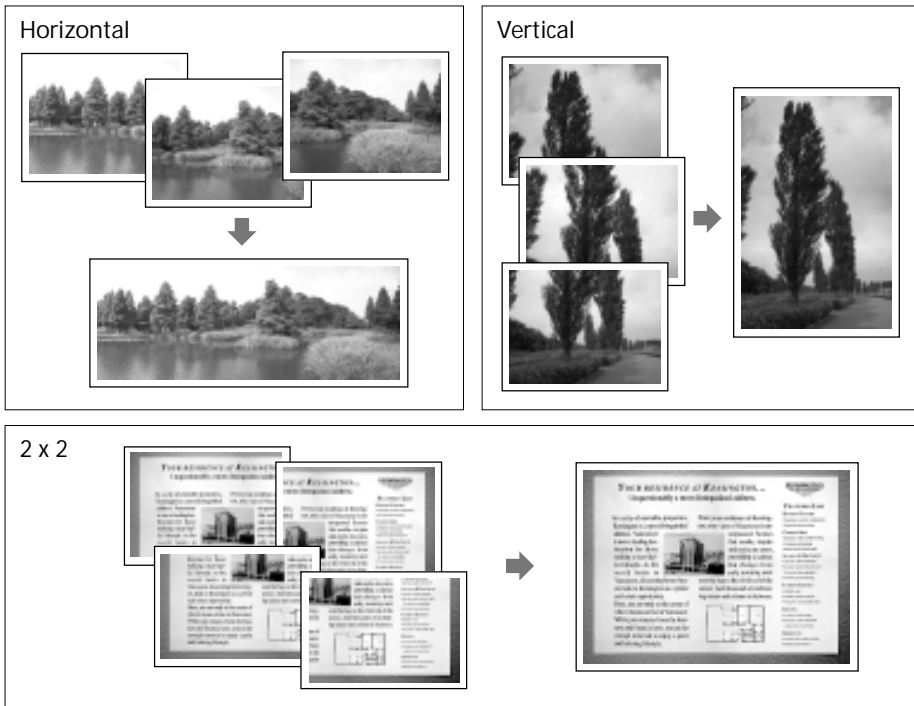

- Please use the bundled PhotoStitch program to merge the images on a computer.

Framing a Subject

PhotoStitch detects the overlapping portions of adjoining images and merges them. When composing shots, try to include a distinctive item (landmark, etc.) in the overlapping portions.

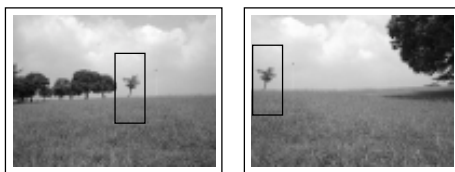







- Compose each frame so that it overlaps 30 to 50% of the adjoining image. Try to keep the vertical misalignment to within 10% of the image height.
- Do not include moving items in the overlap.
- Do not try to stitch images that include both distant and close subjects. Objects may appear warped or doubled up.
- Make the brightness in each image consistent. The final image will appear unnatural if the difference in brightness is too great.
- For good results, pan (swivel) the camera to take successive shots.
- To shoot close-ups, slide the camera over the subject, keeping it parallel as you move.

Shooting

Images can be shot in the following 5 sequences in Stitch Assist mode.

	Horizontally, left to right
	Horizontally, right to left
	Vertically, bottom to top
	Vertically, top to bottom
	Clockwise starting at the top left

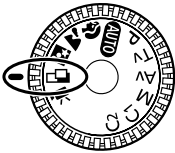

1



Open the LCD monitor and turn the mode dial to .

- The LCD monitor will turn on.

2

Select the shooting sequence using the  or  arrow on the omni selector and press the **SET** button.

- You can also press the shutter button directly to shoot without pressing the **SET** button.





3

Shoot the first image.

- The exposure and white balance settings are set and locked with the first image.

4 Compose and shoot the second image so that it overlaps the first.

- Minor discrepancies in the overlap can be corrected with the software.
- An image can be retaken. Press the ◀ or ▶ arrow on the omni selector to return to that frame.

Sequence Sequence 

5 Use the same procedures to shoot the remaining frames.

- A maximum of 26 images can be recorded either horizontally or vertically.

6 Press the **SET** button after the last shot.





- A custom white balance setting (p. 87) cannot be set in  mode. To use a custom white balance setting, first set it in another shooting mode.
- The settings in place for the first image are locked in and cannot be changed for subsequent shots.
- A TV cannot be used as the monitor for shooting in this mode.





- Functions Available in Each Shooting Mode (p. 204)

Movie Mode

Use this mode to shoot movie frames. The resolution can be set to either  (320 X 240 (default setting)) or  (160 X 120) (p. 55).

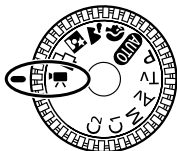
1



Open the LCD monitor and turn the mode dial to .

- The LCD monitor turns on and displays the maximum recording time (in seconds).

2

Press the shutter button all the way.

- Shooting and sound recording starts simultaneously.
- During the shooting a red circle appears in the upper right of the LCD monitor.

3

Press the shutter button all the way to stop recording the movie.

- The maximum length of individual movie clips (approximately 15 frames/second) is about 3 minutes* at the (320 × 240) setting and about 3 minutes* at the (160 × 120) setting. The clip will end automatically after this time elapses or when the CF card becomes full.

* The data reflects Canon's testing standard. The actual figures will vary according to the shooting objects and conditions.



- Be careful not to touch the microphone while shooting.
- The AE, AF, white balance and zoom settings are set and locked to the settings of the first frame.
- If the indicator on the left side of the viewfinder blinks green after a shot, this indicates that the movie is being written to the CF card. You cannot shoot again until it stops blinking.





- Functions Available in Each Shooting Mode (p. 204)
- Sound is recorded monaurally.
- There is no shutter sound in movie mode.
- QuickTime 3.0 or higher is required to replay movie files (AVI / Motion JPEG) on a computer. (QuickTime (for Windows) is bundled on the supplied Digital Camera Solution Disk. On the Macintosh platform, QuickTime 3.0 or later is generally bundled with Mac OS 8.5 or later operating system.)

Macro Mode

Use the macro mode to shoot close-ups of subjects in the range of 5 to 50 cm (0.16 to 1.6 ft.) at wide angle end and 15 to 50 cm (0.49 to 1.6 ft.) at telephoto end.

1 Press the **DISPLAY** button to turn the LCD monitor on.

2 Press the  button.

- The  icon appears on the display panel and on the LCD monitor.
- Press the  button again to cancel the macro mode.

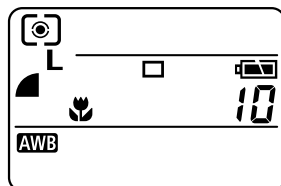

3 Shoot the image.

- The indicator beside the viewfinder will light yellow when the shutter button is pressed halfway.
- Shooting procedures are the same as for the **AUTO** Mode (p. 51).



- In macro mode, the correct image brightness sometimes cannot be obtained with flash photography. Please set the ND filter to [On] and use the separately sold Macro Ring Lite MR-14EX or the Macro Twin Lite MT-24EX for flash photography in the macro mode. Use the **Av** or **M** mode and set the aperture to a higher value as required by the shooting conditions.









- Some settings are not available with certain Shooting modes. Please refer to Functions Available in Each Shooting Mode (p. 204).
- Always use the LCD monitor to compose images in macro mode. Shooting with the viewfinder is possible, though, the parallax phenomenon may cause images composed with the optical viewfinder to be off-center.
- When the lens is zoomed to the wide angle end, the recordable area is approximately 74 x 54 mm (2.9 x 2.1 in.) at the closest focal distance, and at telephoto end, it is approximately 55 x 41 mm (2.2 x 1.6 in.), roughly the size of a business card. If optional Close-up Lens 250D 58mm (p. 184) is used in macro mode, the recordable area is approximately 37 x 27 mm (1.5 x 1.1 in.) at maximum telephoto.

Self-Timer

You can take pictures with the self-timer in any shooting mode.

1 Press the / button.

- Press the  /  button several times to display the  icon in the display panel. The icon will also appear in the LCD monitor if it is on.
- You can cancel the self-timer by pressing the  /  button until the  icon disappears.

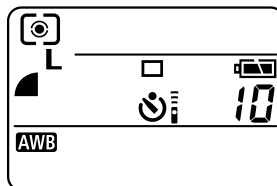

2 Shoot the image.

- When [Self-timer] is set to [10 sec], the self-timer lamp starts blinking when the shutter button is pressed all the way. The self-timer sounds and the blinking gets faster two seconds before the shutter activates.
- When [Self-timer] is set to [2 sec], the self-timer lamp blinks fast from the beginning. The shutter activates in two seconds.
- Shooting procedures are the same as for the **AUTO** mode (p. 51).



- Some settings are not available with certain Shooting modes. Please refer to Functions Available in Each Shooting Mode (p. 204).
- You can change the self-timer sound by changing the setting in [Selftimer Sound] in the  (My Camera) menu (p. 167).

Setting the Number of Seconds until Shooting

You can set the number of seconds from the time the shutter button is pressed to the time the image is shot to 10 seconds or 2 seconds.

1 Select [Self-timer] from the [📷 (Rec.)] menu.

- See Selecting Menus and Settings (p. 42).



2 Select [10 sec] or [2 sec] using the ◀ or ▶ arrow on the omni selector.

3 Press the **SET** button.

Digital Zoom

With the combined optical and digital zoom functions, images can be zoomed as follows.

4.0 times, 5.7 times, 7.1 times, 8.9 times, 11 times, and 14 times

- 1 Press the **DISPLAY** button to turn the LCD monitor on.
- 2 Turn the mode dial to any shooting mode except for  or .
- 3 In the  (Rec.) menu, select [Digital Zoom].
 - See Selecting Menus and Settings (p. 42).
- 4 Select [On] and press the **MENU** button.
- 5 Press the zoom lever toward  and hold it.
 - The lens will zoom to the maximum optical telephoto setting and stop. Release the lever and press it toward  again to further zoom the image digitally.
 - Slide the lever toward  to zoom back out.
- 6 Shoot the image.
 - Shooting procedures are the same as for the **AUTO** mode (p. 51).

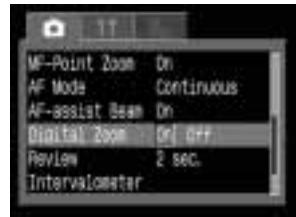



The combined magnifications of the optical zoom and digital zoom are displayed.

.....
 • The digital zoom cannot be used when the LCD monitor is off or with the RAW file format.





.....
 • Some settings are not available with certain Shooting modes. Please refer to Functions Available in Each Shooting Mode (p. 204).
• Images become coarser the more they are digitally zoomed.

Continuous Shooting

Use this mode to shoot successive frames while the shutter button is fully pressed.

	Standard Continuous Shooting	Use this mode to view the images as you shoot continuously. The shutter interval is longer in this mode than in  mode.
	High Speed Continuous Shooting	Use this mode to shoot continuously with a short shutter interval. You cannot check images while shooting continuously.

1 Press the  button.

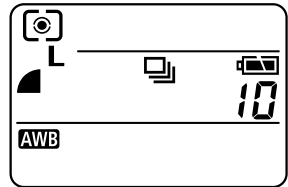

- Press the  button several times to display the  icon in the display panel. The icon will also appear in the LCD monitor if it is on.
- You can cancel the continuous mode by pressing the  button until the  icon disappears.



2 In the [Rec.] menu, select [Cont. Shooting].

- See Selecting Menus and Settings (p. 42).



3 Select  or  and press the **SET** button.

4 Press the shutter button halfway to lock the focus.

5 Press the shutter button all the way to shoot.

- Shooting will stop when the shutter button is released.
- The shooting speed is as follows.*

When  is selected: Approx. 1.5 frames per second

When  is selected: Approx. 2.5 frames per second

* Large/Fine, LCD monitor off mode. (These figures reflect Canon's testing standard. The actual figures will vary according to the shooting conditions and settings.)



- Some settings are not available with certain Shooting modes. Please refer to Functions Available in Each Shooting Mode (p. 204).
- The interval between frames may lengthen somewhat when the internal memory becomes full.
- The built-in flash can be used, but the interval between images will lengthen to accommodate the flash recharge time.
- The flash will not fire with an externally mounted flash.
- Turning the camera off restores the standard shooting mode. However, the selected continuous shooting option will remain effective the next time continuous shooting is activated, making it possible to skip steps 2 and 3 above if you wish to use the same option.

Shooting - Selecting Particular Effects

Camera settings such as shutter speed and aperture can be freely changed for shooting.

See Functions Available in Each Shooting Mode (p. 204) at the end of this manual to find out which settings can be changed in which shooting modes.



- Please see **AUTO** Mode (p. 51) for shooting procedures once you have changed a setting.

P Program AE

Use the program AE mode to have the camera automatically set the shutter speed and aperture value to match the brightness of the scene.

1

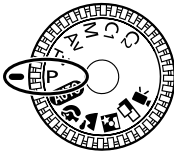

Turn the mode dial to **P**.

2

Shoot the image.

- The shutter speed and aperture value will be set automatically and shown in the display panel. They will also appear in the LCD monitor if it is on.
- The correct exposure has been set if the shutter speed and aperture value appear in white in the LCD monitor.

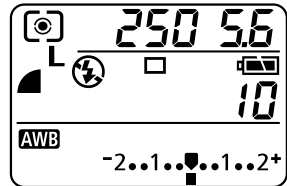



- Functions Available in Each Shooting Mode (p. 204)
- If a correct exposure cannot be obtained, the shutter speed and aperture value show in red on the LCD monitor. Use the following methods to obtain the correct exposure and make them show in white.
 - Use the flash.
 - Change the ISO speed setting.
 - Change the light metering mode.

Differences and Similarities between the **P** and **AUTO** Modes.

- Both modes automatically select the shutter speed and aperture value.
- The following settings can be adjusted in **P** mode, but not in **AUTO** mode.
 - Exposure Compensation
 - ISO Speed
 - Flash Exposure Compensation
 - Built-In Flash (Flash on, Slow Synchro, 2nd-curtain flash)
 - Continuous Shooting
 - Light Metering Mode
 - AF frame
 - FE Lock
 - White Balance
 - Bracket Mode
 - Photo Effect
 - File Format Settings
 - Manual Focus
 - AE Lock
 - ND Filter

Tv Setting the Shutter Speed

When you set the shutter speed in the shutter speed-priority AE mode, the camera automatically selects an aperture value to match the brightness. Faster shutter speeds allow you to catch an instantaneous image of a moving subject while slower speeds create a flowing effect and allow you to shoot without a flash in dark areas.

1

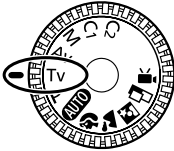

Turn the mode dial to **Tv**.

- The shutter speed will show in the display panel. It will also appear on the LCD monitor if it is on.

2

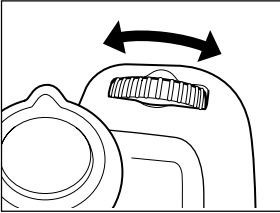

Turn the main dial and select a shutter speed.

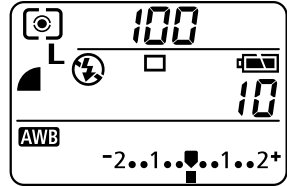

3

Shoot the image.

- The correct exposure has been set if the shutter speed and aperture value show in white in the LCD monitor.

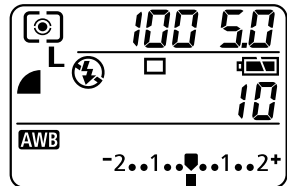

- If the aperture value is shown in red in the LCD monitor, the image is under exposed (insufficient light) or overexposed (too much light). Adjust the shutter speed using the main dial until the aperture value display turns to white.
- The nature of CCD image sensors is such that noise in the recorded image increases at slow shutter speeds. This camera, however, applies special processing to images shot at shutter speeds slower than 1.3 seconds to eliminate the noise, thereby producing high-quality images. Nevertheless, a certain amount of processing time may be required before the next image can be shot.

Tv Setting the Shutter Speed (continued)



- Functions Available in Each Shooting Mode (p. 204)
- Please note that camera shake becomes a factor at low shutter speeds. If the camera shake warning  appears in the center of the LCD monitor, secure the camera to a tripod before shooting.
- The fastest shutter speed for flash synchronization is 1/250 second. The camera automatically resets the shutter speed to 1/250 second if a faster speed is selected.
- The aperture value and shutter speed change according to the zoom state as follows.

	Aperture	Shutter Speed (seconds)
Wide Angle	F 2.0 - 3.5	to 1/1250
	F 4.0 - 8.0	to 1/2000
Telephoto	F 3.0 - 5.0	to 1/1250
	F 5.6 - 8.0	to 1/2000

Shutter Speed Display

The shutter speeds from 2000 to 4 in the display are actually the denominator of a fraction of a second. For example, 160 indicates a speed of 1/160 second. For slower speeds, quote marks indicate the decimal place, so that 0"3 indicates 0.3 second and 2" indicates 2 seconds.

2000	1600	1250	1000	800	640	500	400	320	250		
200	160	125	100	80	60	50	40	30	25	20	15
13	10	8	6	5	4						
0"3	0"4	0"5	0"6	0"8	1"	1"3	1"6	2"	2"5	3"2	
4"	5"	6"	8"	10"	13"	15"					

The display of shutter speeds from 1/4 to 1/2000 second differs between the display panel and LCD monitor.

Shutter Speed	1/2000 sec. . . .	1/4 sec. . . .	0.8 sec. . . .	15 sec.
Display Panel	2000 . . .	4 . . .	0"8 . . .	15"
LCD Monitor	1/2000 . . .	1/4 . . .	0"8 . . .	15"

Av Setting the Aperture

When you set the aperture in the aperture-priority AE mode, the camera automatically selects a shutter speed to match the brightness. Selecting a lower aperture value (opening the aperture) allows you to fade the background and create a beautiful portrait. A higher aperture value (closing it) brings the entire range from foreground to background into focus. The larger the aperture value, the greater the range of the image brought into clear focus.

1

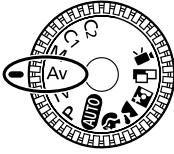

Turn the mode dial to **Av**.

- The aperture value will show in the display panel. It will also appear on the LCD monitor if it is on.

2

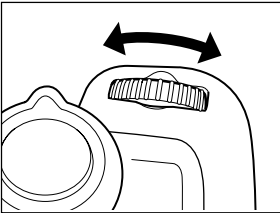

Turn the main dial and select an aperture value.

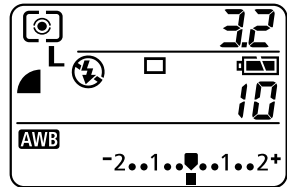

3

Shoot the image.

- The correct exposure has been set if the shutter speed and aperture value show in white in the LCD monitor.

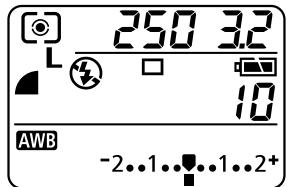

Av Setting the Aperture (continued)



- If the shutter speed shows in red in the LCD monitor, the image is under exposed (insufficient light) or overexposed (too much light). Adjust the aperture value using the main dial until the shutter speed display turns to white.
- Depending on the zoom position, certain aperture values may not be available.



- Functions Available in Each Shooting Mode (p. 204)
- Please note that camera shake becomes a factor at low shutter speeds. If the camera shake warning  appears in the LCD monitor, secure the camera to a tripod before shooting.
- In this mode, the shutter speed with synchronized flash is 1/60 second to 1/250 second. The aperture value setting may therefore be changed automatically to match the synchronized flash speed even if its value was set previously.
- For the correlation between aperture value and shutter speed, see page 78.

Aperture Setting Display

The larger the aperture value, the smaller the lens aperture.

F2.0	F2.2	F2.5	F2.8	F3.0	F3.2	F3.5	F4.0	F4.5	F5.0
F5.6	F6.3	F7.1	F8.0						

The display of aperture settings differs between the display panel and LCD monitor.

Aperture Value	F2.0	. . .	F8.0
Display Panel	2.0	. . .	8.0
LCD Monitor	F2.0	. . .	F8.0

M Manually Setting the Shutter Speed and Aperture

You can manually set the shutter speed and aperture to achieve a particular effect. This is convenient for shooting fireworks and other images where it is difficult to set the correct exposure automatically.

1

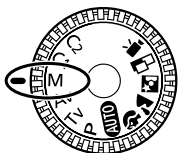

Turn the mode dial to **M**.

- The shutter speed and aperture setting will show in the display panel. They will also appear on the LCD monitor if it is on.

2

Click the main dial and select a setting content (shutter speed or aperture value).

- Clicking the main dial switches between the shutter speed and the aperture value setting.

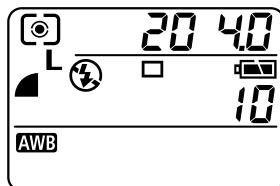

3

Turn the main dial and select a shutter speed or an aperture value.

4

Shoot the image.



- When you press the shutter button halfway, the exposure compensation bar displays in the display panel and a number in the LCD monitor indicates the difference between standard exposure* and the selected exposure. If the difference is more than ± 2 stops, the LCD monitor shows a red “-2” or “+2”.



Displays in red

* The standard exposure is calculated by the AE function according to the selected metering method.



- Functions Available in Each Shooting Mode (p. 204)
- For the correlation between aperture value and shutter speed, see page 78.
- If you wish to change the exposure, adjust the shutter speed or the aperture using the main dial.
- When you select a fast shutter speed or shoot a subject in a dark place, set the flash to  (Red-Eye Reduction, Flash On) or  (Flash On), or attach an externally mounted flash so that the LCD monitor's brightness matches the selected shutter speed and aperture value. The LCD monitor will always light up when the flash is on.



Selecting an AF Frame

The AF frame indicates the area of the composition on which the camera focuses and can be set manually to the desired area. This is convenient for focusing accurately on an off-center subject to obtain the composition you desire. However, the AF frame is fixed to center-point when an image is shot using the viewfinder with the LCD monitor off or when using the digital zoom, even if you previously set the AF frame to the position you desire.

1 Press the **DISPLAY** button to turn on the LCD monitor.

2 Press the  button.

- The AF frame appears in green on the LCD monitor.



3 Move the AF frame to the desired area using the **▲**, **▼**, **◀** or **▶** arrows on the omni selector.

4 Press the  button.

- You can immediately shoot the image using the selected AF frame by pressing the shutter button instead of pressing the  button.



5 Shoot the image.



- Some settings are not available with certain Shooting modes. Please refer to Functions Available in Each Shooting Mode (p. 204).
- The AF frame will move back to its original position (Center) if you hold down the  button.
- The AF frame can also be moved in the macro mode.
- The AF frame can be set in both the macro mode and the standard mode.
- The AF frame cannot be moved while focusing manually.
- When the Spot AE Point is selected as the light metering mode, you can use the selected AF frame as the Spot AE Point (p. 83).
- For an explanation of the AF frame colors, please refer to page 39.

Switching between Light Metering Modes

Evaluative Metering is the default light metering mode. This can be switched to another metering mode.



	Evaluative Light Metering	Appropriate for standard shooting conditions, including backlit scenes. The camera divides images into several zones for light metering. The camera evaluates the complex lighting conditions, such as the position of the subject, the brightness, the background, the direct light, and the backlighting, and adjusts the settings to the correct exposure for the main subject.
	Center-Weighted Averaging	Averages the exposure from the entire image, but places more weight on the subject at the center. Use this mode when the subject is backlit or surrounded by bright light.
	Center	Meters the area within the spot AE point frame at the center of the LCD monitor.
	AF Point	Meters the spot AF point corresponding to the AF frame.

1 Press the **DISPLAY** button to turn on the LCD monitor.

2 Press the  button to select the metering mode.

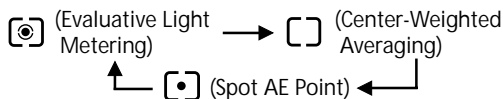
- Each press of the  button changes the metering mode as follows.



- The icon of the currently selected light metering mode appears on the display panel. It also appears on the LCD monitor if it is on.
- If you have selected  (Spot AE Point), go to step 3.
 If you have selected  (Evaluative Light Metering) or  (Center-Weighted Averaging), go to step 5.

3 In the [ (Rec.)] menu, select [Spot AE Point].

- See Selecting Menus and Settings (p. 42).



4 Select the [Center] or [AF Point] option, then press the **MENU** button.

- When [Spot AE Point] is set to [Center], the spot AE point frame appears at the center of the LCD monitor, and when [Spot AE Point] is set to [AF Point], it appears inside the AF frame.



e.g. Center

Spot AE Point Frame

5 Shoot the image.



• Some settings are not available with certain Shooting modes. Please refer to Functions Available in Each Shooting Mode (p. 204).

Adjusting the Exposure

Adjust the exposure compensation setting to avoid making the subject too dark when it is backlit or shot against a bright background.

- 1 Press  (▲ on the omni selector).
 - The exposure compensation bar will appear in the display panel. The bar will also appear in the LCD monitor if it is on.

- 2 Select a setting using the main dial or the ◀ or ▶ arrow on the omni selector.
 - The settings can be adjusted in 1/3 steps in the range of -2EV to +2EV.
 - You can shoot the image right after selecting settings by pressing the shutter button. This screen will appear again, once the image is shot.

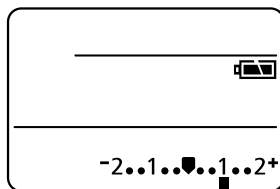

- 3 Press the **SET** button or click the main dial.
 - To cancel the exposure compensation, return the setting to 0 using the main dial or the ◀ or ▶ arrow on the omni selector.









- 4 Shoot the image.



-
- Some settings are not available with certain Shooting modes. Please refer to Functions Available in Each Shooting Mode (p. 204).

WB Setting the White Balance

When the white balance mode is set to match the light source, the camera reproduces colors more accurately.

	Auto	Settings are automatically set by the camera
	Daylight	For recording outdoors on a bright day
	Cloudy	For recording under overcast, shady or twilight skies
	Tungsten	For recording under tungsten and bulb-type 3-wavelength fluorescent lighting
	Fluorescent	For recording under warm-white, cool-white or warm-white (3-wavelength) fluorescent lighting
	Fluorescent H	For recording under daylight fluorescent, or daylight fluorescent-type 3-wavelength fluorescent lighting
	Flash	For flash photography
	Custom1	For setting a custom value with a white sheet of paper, etc., to obtain the optimal white balance
	Custom2	for the conditions. There are two custom values: custom1 and custom2.

- 1 Press **WB** (▼ on the omni selector).
 - The current white balance mode will appear in the display panel. The white balance settings menu will appear in the LCD monitor if it is on.

- 2 Select the desired setting using the main dial or the ◀ or ▶ arrow on the omni selector.

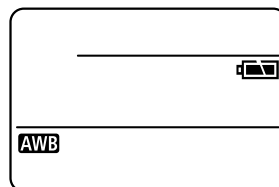

- Please see the next page regarding the  custom setting.
- You can shoot the image right after selecting settings by pressing the shutter button. This screen will appear again, once the image is shot.



- 3 Press the **SET** button or click the main dial.

- 4 Shoot the image.

.....

- The white balance cannot be adjusted when the photo effect is set to  (Sepia) or  (B/W).

📷 Setting a Custom White Balance

You can set a custom white balance to obtain the optimal setting for the shooting conditions by having the camera evaluate a subject such as a white piece of paper or cloth, or a photo-quality gray card. You can set two different custom settings.

- 1 Press **WB** (▼ on the omni selector).
 - The white balance mode appears on the display panel and the white balance settings appear on the LCD monitor if it is on.

- 2 Select 📷1 (Custom1) or 📷2 (Custom2) using the main dial or the ◀ or ▶ arrow on the omni selector.







- 3 Aim the camera at the white paper or cloth, or gray card and press the * button.
 - Aim the camera so that the white paper or cloth, or gray card, completely fills the frame on the LCD monitor screen or the entire viewfinder before pressing the * button. When you press the * button, the camera reads the white balance data.
 - You can shoot the image right after selecting settings by pressing the shutter button. The previous screen will appear again, once the image is shot.

- 4 Press the **SET** button or click the main dial.

- 5 Shoot the image.

WB Setting the White Balance (continued)



- Some settings are not available with certain Shooting modes. Please refer to Functions Available in Each Shooting Mode (p. 204).
- To set and use a custom white balance setting, it is advisable to select the **P** shooting mode and set the exposure compensation and flash exposure compensation to zero (± 0). The correct white balance may not be obtained when the exposure is incorrect (image is completely black or white).
- It is also advisable to use the LCD monitor to compose the shot and to zoom in to the maximum telephoto setting.
- Since the white balance data cannot be read in  mode, preset the white balance in another shooting mode first before selecting  mode.
- Set the flash on or off when setting a custom white balance. The white balance may not be accurate if the setting conditions and shooting conditions are not the same. If the flash fires when setting a custom white balance with the flash set to  or , ensure that you also use the flash when you go to shoot.
- The custom white balance setting is not cancelled even if settings are reset to default settings (p. 168).



Changing the Photo Effect

You can shoot with different photo effects.

OFF /	Photo Effect Off	Records with no effect.
1 /	Vivid	Emphasizes the contrast and color saturation to record in bold color.
2 /	Neutral	Tones down the contrast and color saturation to record neutral hues.
3 /	Low Sharpening	Records subjects with softened outlines.
4 /	Sepia	Records in sepia tones.
5 /	B/W	Records in black and white.
6 /	Custom Effect	You can freely set the contrast, sharpness and color saturation.

1

Press the **DISPLAY** button to turn the LCD monitor on.

- Photo Effect settings can be changed even if the LCD monitor is off. However, the Custom Effect settings cannot be changed.

2

Press the **FUNC.** button.

3

Select * (LCD monitor) Or OFF* (Display Panel) using the ▲ or ▼ arrow on the omni selector.

- * The current setting is displayed.
- The Photo Effect setting menu appears on the LCD monitor.

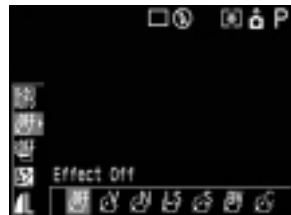

4

Select the desired setting using the main dial or the ◀ or ▶ arrow on the omni selector.

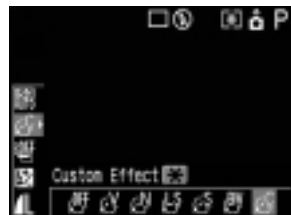

Changing the Photo Effect (continued)

When  is selected

- A screen allowing you to set the contrast, sharpness and color saturation appears when you press the * button.
In this screen, select the item you wish to set using the ▲▼ arrows on the omni selector and set it using the ◀▶ arrows on the omni selector.

Contrast

- Select from - (Weak), 0 (Neutral) and + (Strong).
- This function allows you to adjust the degree of brightness.

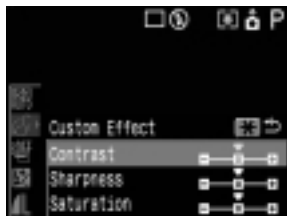

Sharpness

- Select from - (Weak), 0 (Neutral) and + (Strong).
- This function allows you to adjust how sharply outlines are defined.

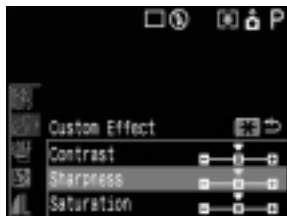

Saturation

- Select from - (Low), 0 (Neutral) and + (High).
- This function allows you to adjust the color depth.

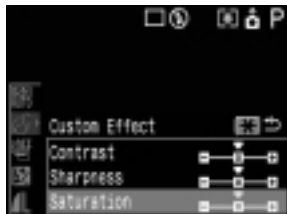

- You can shoot the image right after selecting settings by pressing the shutter button. This screen will appear again, once the image is shot.

5 Press the **FUNC.** button, the **SET** button or click the main dial.

6 Shoot the image.



- The white balance cannot be set when  (sepia) or  (B/W) mode is selected.



- Some settings are not available with certain Shooting modes. Please refer to Functions Available in Each Shooting Mode (p. 204).



ISO Changing the ISO Speed

Change the ISO speed when shooting in dark places or when you want to shoot with a faster shutter speed. You can choose from the following speeds: Auto, 50, 100, 200 and 400.

1 Press the **DISPLAY** button to turn the LCD monitor on.

2 Press the **FUNC.** button.

3 Select * (LCD monitor) or *ISO AUTO** (Display Panel) using the **▲** or **▼** arrow on the omni selector.

* The current setting is displayed.

- The ISO speed setting menu appears on the LCD monitor.



4 Select the desired setting using the main dial or the **◀** or **▶** arrow on the omni selector.

- You can shoot the image right after selecting settings by pressing the shutter button. This screen will appear again, once the image is shot.

5 Press the **SET** button, the **FUNC.** button or click the main dial.

6 Shoot the image.



- Higher ISO speeds increase the image noise. To take clean images, use as low an ISO speed as possible.



- Some settings are not available with certain Shooting modes. Please refer to *Functions Available in Each Shooting Mode* (p. 204).



Auto Exposure Bracketing (AEB Mode)

In this mode, the camera automatically changes the exposure within a set range to take three shots after you press the shutter button once. You can adjust AEB settings in 1/3EV steps within the range of -2EV to +2EV of the standard exposure setting. AEB settings can be combined with exposure compensation settings (p. 85) to extend the adjustment range. The images are shot in the following order: Standard exposure, underexposure and overexposure.

- 1 Press the **DISPLAY** button to turn the LCD monitor on.
 - The AEB mode can be set even if the LCD monitor is off. However, the compensation range cannot be adjusted.

- 2 Press the **FUNC.** button.

- 3 Select * (LCD monitor) or **BKT OFF*** (Display Panel) using the **▲** or **▼** arrow on the omni selector.

* The current setting is displayed.

- The Bracket setting menu appears on the LCD monitor.



- 4 Select  (LCD monitor) or **BKT AE-b** (Display Panel) using the main dial or the **◀** or **▶** arrow on the omni selector and press the ***** button.

- The compensation range cannot be adjusted when the LCD monitor is off, even if you press the ***** button. Press the **FUNC.** button or the **SET** button to end the operation. You can use the AEB operations with the currently selected compensation range.



- 5 Expand or contract the range using the main dial or the ◀ or ▶ arrow on the omni selector.
- Use ▶ to expand the range and ◀ to contract it.
 - The camera returns to the Step 4 screen if you press the * button.
 - You can shoot the image right after selecting settings by pressing the shutter button. This screen will appear again, once the image is shot.



- 6 Press the **SET** button, the **FUNC.** button or click the main dial.
- Select  or **BKT OFF** in Step 4 to cancel the AEB mode.

- 7 Shoot the image.



- The AEB mode cannot be used for flash photography. If the flash fires, only one image gets recorded.



- Some settings are not available with certain Shooting modes. Please refer to Functions Available in Each Shooting Mode (p. 204).

Focus Bracketing (Focus-BKT Mode)

You can shoot three images while the focus changes automatically when shooting with the manual focus (p. 106). Three ranges -small, medium or large- can be selected. Images are shot with the focus position changing in the following order: selected position, further away and closer.

- 1 Press the **DISPLAY** button to turn the LCD monitor on.
 - Focus Bracketing settings can be selected even if the LCD monitor is off. However, the range cannot be adjusted.

- 2 Press the **FUNC.** button.

- 3 Select * (LCD monitor) or **BKT OFF*** (Display Panel) using the ▲ or ▼ arrow on the omni selector.

* The current setting is displayed.

- The Bracket setting menu appears on the LCD monitor.



- 4 Select  (LCD monitor) or **BKT FC-b** (Display Panel) using the main dial or the ◀ or ▶ arrow on the omni selector and press the * button.

- The range cannot be adjusted when the LCD monitor is off, even if you press the * button. Press the **FUNC.** button or the **SET** button to end the operation. You can use the Focus Bracketing operations with the currently selected range.



Focus Bracketing (Focus-BKT Mode) (continued)

5 Select a range using the main dial or the ◀ or ▶ arrow on the omni selector.

- The range expands when you press ▶ and contracts when you press ◀.
- The camera returns to the Step 4 screen if you press the * button.
- You can shoot the image right after selecting settings by pressing the shutter button. This screen will appear again, once the image is shot.



6 Press the **SET** button, the **FUNC.** button or click the main dial.

7 Shoot the image in manual focus (p. 106).



- The Focus-BKT mode is not available when shooting with the flash on. The camera will revert to shooting only one image when the flash is on.



- Some settings are not available with certain Shooting modes. Please refer to Functions Available in Each Shooting Mode (p. 204).

* Locking the Exposure Setting (AE Lock)

You can set the exposure and focus separately. This is effective when the contrast is too strong between the subject and background or when a subject is backlit.

1 Press the **DISPLAY** button to turn on the LCD monitor.

2 Focus the AF frame or the spot metering frame on the subject on which you wish to lock the exposure setting and press the shutter button halfway.

- Selecting an AF frame (p. 82).
- Switching Between Light Metering Modes (P. 83)

3 While pressing the shutter button halfway, press the * button.

- The exposure setting locks (AE lock) and the * icon appears on the LCD monitor.
- Using any button, lever or switch other than the main dial cancels the AE lock.



AE Lock Icon

4 Recompose the image and shoot.

- The AF frame focuses on the subject.



* Locking the Exposure Setting (AE Lock) (continued)



- The AE lock function cannot be used when the LCD monitor is off.



- Some settings are not available with certain Shooting modes. Please refer to Functions Available in Each Shooting Mode (p. 204).
- The automatically selected combinations of shutter speeds and aperture values can be freely changed without altering the exposure with the following procedures.
 - 1 Turn the mode dial to **P**, **Tv** or **Av**.
 - 2 Press the **DISPLAY** button to turn on the LCD monitor.
 - 3 Focus on the subject on which you wish to lock the exposure.
 - 4 Press the * button.
 - The exposure setting will lock and the * icon will appear in the LCD monitor.
 - 5 Turn the main dial until the desired shutter speed or aperture value is reached.
 - 6 Recompose the image and shoot.
 - The setting will cancel after the shot is taken.

* Locking the Flash Exposure Setting (FE Lock)

You can obtain the correct exposure regardless of the location of your subject in the composition.

1 Press the **DISPLAY** button to turn on the LCD monitor.

2 Press the **⚡** (Flash) button and set the flash to fire (p. 60).
• If you are using an externally mounted flash, please refer to its manual for setting instructions.

3 Focus the AF frame or the spot metering frame on the subject on which you wish to lock the flash exposure setting and press the shutter button halfway.

4 While pressing the shutter button halfway, press the ***** button.
• The flash exposure compensation setting locks (FE lock) and the ***** icon appears on the Display Panel and on the LCD monitor.
• The flash will fire a pre-flash and lock the flash exposure to the required intensity to illuminate the subject. (Each time you press the ***** button, the flash exposure locks at the required intensity for that composition.)
• Using any button, lever or switch other than the omni selector cancels the FE lock.

5 Recompose the image and shoot.



- The FE lock only functions with the built-in flash, an externally mounted EX series Speedlite, a Macro Ring Lite or a Macro Twin Lite.
- The FE lock function is not available when [Flash Adjust] is set to [Manual].
- Some settings are not available depending on the Shooting mode. Please refer to Functions Available in Each Shooting Mode (p. 204).



Switching between Flash Adjustment Settings

The built-in flash and the externally mounted flash* fire with automatic flash adjustments (except in the **M** mode), but it is possible to set them so that they fire without any adjustments.

*Speedlite 220EX/380EX/420EX/550EX, Macro Ring Lite MR-14EX, Macro Twin Lite MT-24EX

- 1 Select [Flash Adjust] from the [(Rec.)] menu.
 - See Selecting Menus and Settings (p. 42).

- 2 Select [Auto] or [Manual] and press the **MENU** button.

Compensating the Flash Adjustment ((Flash))

The flash adjustment can be changed when [Flash Adjust] is set to [Auto]. The settings can be adjusted in 1/3-stop increments in the range of -2EV to +2EV. You can enjoy flash photography with exposure adjustments with the combined use of the camera's exposure compensation function.

- 1 Press the **DISPLAY** button to turn on the LCD monitor.
- 2 Press the **FUNC.** button.
- 3 Select using the ▲ or ▼ arrow on the omni selector.
- 4 Adjust the compensation using the main dial or the ◀ or ▶ arrow on the omni selector.
 - You can shoot the image right after selecting settings by pressing the shutter button. This screen will appear again, once the image is shot.



e.g. Flash Adjustment Settings

-
- 5 Press the **SET** button, the **FUNC.** button or click the main dial.
- To cancel the compensation, return the setting to  using the main dial or the ◀ or ▶ arrow on the omni selector.
-

6 Shoot the image.

Compensating the Flash Output.

In **M** mode or when [Flash Adjust] is set to [Manual], the flash output can be controlled in three steps, starting from FULL, when shooting. This setting is also active with slave flash photography where multiple flashes are fired at the subject from different positions because the pre-flash does not fire. When an externally mounted flash is attached, its flash output can be controlled (Up to 1/16 from Full, in 1/3 steps).

1 Press the **DISPLAY** button to turn on the LCD monitor.

2 Press the **FUNC.** button.

3 Select  using the ▲ or ▼ arrow on the omni selector.

4 Adjust the output using the main dial or the ◀ or ▶ arrow on the omni selector.

- You can shoot the image right after selecting settings by pressing the shutter button. This screen will appear again, once the image is shot.

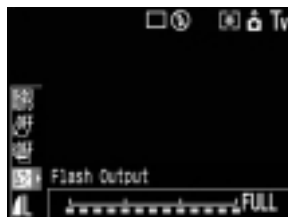

e.g. Flash Output

5 Press the **SET** button, the **FUNC.** button or click the main dial.

6 Shoot the image.



- Some settings are not available with certain Shooting modes. Please refer to Functions Available in Each Shooting Mode (p. 204).

Switching the Timing at which the Flash Fires

1st-curtain	The flash fires right after the shutter opens, regardless of the shutter speed. Usually, the 1st-curtain is used when shooting.
2nd-curtain	The flash fires right before the shutter closes, regardless of the shutter speed. Compared with the 1st-curtain, the flash fires later and this allows you to shoot images in which, for example, a car's rear lamps seem to trail off behind.



Image shot with the 1st-curtain setting



Image shot with the 2nd-curtain setting.

- 1 From the [ (Rec.)] menu, select [1st-curtain] or [2nd-curtain] in [Flash Sync].



- Some settings are not available with certain Shooting modes. Please refer to Functions Available in Each Shooting Mode (p. 204).

Shooting Images at Set Intervals (Intervalometer)

You can shoot images at a set interval. This function can be used for fixed-point observation of plants and blooming flowers. The shooting interval time can be set from 1 to 60 minutes and 2 to 100 images can be shot.



- Since the camera may shoot continuously for an extended period of time, the use of the Compact Power Adapter CA-560 is recommended (p. 21).

1 Select [Intervalometer] from the [] (Rec.) menu.

- See Selecting Menus and Settings (p. 42).



2 Select an interval time using the ◀ or ▶ arrow on the omni selector.

- If you press the omni selector continuously, the interval time increases by units of 5 minutes at a time.

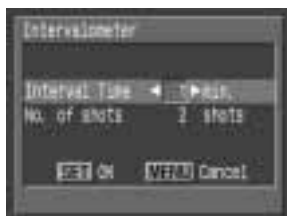

3 Press the ▼ arrow on the omni selector.



4 Select the number of shots using the ◀ or ▶ arrow on the omni selector.

- If you press the omni selector continuously, the number of shots increase by units of 5 shots at a time.
- The maximum number of shots* is determined according to the CF card's remaining capacity.

* The maximum number of shots may decrease according to the images shot.



- 5 Press the **SET** button.
- *Int* appears on the display panel.

- 6 Press the shutter button.
- The first image is shot and the interval shooting session starts.
 - Once the set number of shots is taken, the camera automatically powers down regardless of the power-saving function settings.
 - If the below operations are accessed while the interval shooting is in process, the interval shooting session will be cancelled.
 - Turning the mode dial while the camera is waiting to shoot the next image
 - Pressing the shutter button halfway while the camera is waiting to shoot the next image
 - Opening the CF card slot/battery cover
 - Switching to Replay mode
 - Turning off the power



- Once the interval shooting session is started, all operation buttons become inactive. Turning the mode dial cancels the interval shooting session.
- The lens stays extended until the next image is shot.
- Images are not displayed on the LCD monitor right after being shot.
- Continuous Shooting (normal, high-speed) and Self-timer are not available.
- Interval shooting is not available when the date and time are not set.
- The AEB mode and the Focus-BKT mode settings cannot be set.
- The battery cannot be charged in the camera even if the Compact Power Adapter CA-560 is connected.



- Some settings are not available with certain Shooting modes. Please refer to Functions Available in Each Shooting Mode (p. 204).

Shooting Problem Subjects for the Autofocus

The autofocus may not work well on the following types of subjects.

- Subjects with extremely low contrast to the surroundings
- Subjects mixing close and far objects
- Subjects with extremely bright objects at the center of the composition
- Subjects that are moving quickly

To shoot these subjects, first aim the camera at an object at a similar distance, lock the focus and recompose the image with the desired subject, or use the manual focus.

Shooting with Focus Lock

Focus Lock Method 1

- 1 Aim the center of the optical viewfinder or, if an AF frame is selected, the AF frame to an object at a similar distance to the subject you wish to shoot.
- 2 Press the shutter button halfway to lock the focus.
 - The AE setting will also lock when you do this. The exposure may occasionally be incorrect if the difference between the two items is too great. Use Method 2 or the AE lock procedure when this happens.
- 3 Keep it pressed while you recompose the image and press the shutter button all the way to shoot the image.

Focus Lock Method 2

- 1 Press the **DISPLAY** button to turn on the LCD monitor.
- 2 Press the shutter button halfway to lock the focus. Keep it pressed and press the **MF** button.
 - The **MF** icon appears on the LCD monitor.
 - The focus setting will lock even if the shutter button and the **MF** button are released.
 - The manual focus setting will cancel if the **MF** button is pressed again.

Shooting Problem Subjects for the Autofocus (continued)

3 Recompose the image and press the shutter button all the way to shoot the image.



- Focus lock cannot be used while the shooting mode is set to **AUTO**.



- Method 2 is convenient because you can let go of the shutter button to recompose the image.
- When shooting through glass, get as close as possible to avoid reflection off the glass.

Shooting in Manual Focus Mode

The focus can be manually set.

1 Press the **DISPLAY** button to turn on the LCD monitor.





2 Press the **MF** button.

- The  icon and the MF indicator will appear on the LCD monitor.



MF indicator

3 Turn the main dial to focus.

- The AF frame area is magnified when [MF-Point Zoom] is set to [On] in the [ (Rec.)] menu.*
 - * Except in the  and  modes, when the digital zoom is activated or a TV is used as the display.
 - * Can also be set so that the image displayed is not magnified (p. 159).
- The MF indicator shows approximate figures. Use them as a shooting guideline only.
- Adjust the focus by turning the main dial until the image appears focused on the LCD monitor.
- In **Tv**, **Av** or **M** mode, you can switch between the manual focus, aperture value and shutter speed selection by clicking the main dial. A green  appears at the left of selectable items.
- Pressing the **MF** button a second time cancels the manual focus mode.

4 Shoot the image.

- The indicator beside the viewfinder lights yellow when the shutter button is pressed halfway.

Using the Manual Focus in Combination with the Auto Focus

The camera automatically searches for a more suitable focusing point from the current manually focused location.

1 Focus the camera with the manual focus.

2 Press the **SET** button.

- The camera focuses automatically to a more accurate focusing point near the current focusing point.



- You cannot change the AF frame setting while focusing manually. Cancel the manual focus mode, then change the AF frame setting. With the changed AF frame setting, you can resume the manual focus mode.



- Some settings are not available with certain Shooting modes. Please refer to Functions Available in Each Shooting Mode (p. 204).
- You can use manual focus in the macro focal distance 5 to 50 cm (0.16 to 1.6 ft.) at wide angle end and 15 to 50 cm (0.49 to 1.6 ft.) at telephoto end. In this case, the fine scale is adopted.
- You can change the MF indicator displayed distance units (p. 164).

Switching between Focus Settings

You can switch between focus settings to shoot.

Continuous	The camera is continually focusing on whatever it is aimed even when the shutter button is not pressed, allowing you to shoot without missing opportunities. This is the default setting.
Single	The camera only focuses when the shutter button is pressed halfway, conserving battery power.

- 1 In the [RECALL] (Rec.) menu, select [AF Mode].
 - See Selecting Menus and Settings (p. 42).



- 2 Select [Continuous] or [Single] and press the **MENU** button.

- 3 Shoot the image.

.....



- When the LCD monitor is off, the setting locks in the Single mode.

C1 C2 Saving Custom Settings

You can save frequently used shooting modes and various shooting settings to the **C** (custom) mode. This camera is equipped with two modes ([C1] and [C2]), allowing you to save two types of custom settings. When necessary, you can then shoot images with previously saved settings by simply turning the mode dial to **C1** or **C2**. Settings that are usually forgotten when the shooting mode is changed or when the power is turned off (such as Macro mode or Drive mode) are also remembered.

Settings that can be saved to the C1/C2 mode

- Shooting mode (**P**, **Tv**, **Av**, **M**)
- **P**, **Tv**, **Av** and **M** mode items that can be saved (p. 204)
- Shooting menu settings
- Zoom location
- Manual Focus location

1 Turn the mode dial to **P**, **Tv**, **Av**, **M**, **C1** or **C2**.

2 Set the setting contents you wish to save.

3 Select [Save settings] from the [☐ (Rec.)] menu.

- See Selecting Menus and Settings (p. 42).



4 Select [C1] or [C2] and press the **SET** button.

- Selects a save destination (C1 or C2).

5 Press the **MENU** button.





- When you wish to re-save partially modified settings (except shooting mode) that were previously saved in the **C1** / **C2** mode, select **C1** / **C2** in Step 1.
- The setting contents do not influence other shooting modes.
- Saved settings can be reset (p. 168).

Using the ND Filter

The brightness can be decreased by setting the ND filter on. This allows you to select a smaller aperture and a slower shutter speed than usual.

- 1 Press the **DISPLAY** button to turn on the LCD monitor.
- 2 Select [ND Filter] in the [ (Rec.)] menu.
 - See Selecting Menus and Settings (p. 42).
- 3 Select [On] and press the **MENU** button.
 - **ND** appears on the Display Panel. **ND** also appears on the LCD monitor if it is on.

.....
 • Always use a tripod to prevent camera shake in this mode.
.....

 • Some settings are not available with certain Shooting modes. Please refer to Functions Available in Each Shooting Mode (p. 204).
• Standard brightness is decreased to approximately 1/8 when the ND filter is on. For example, if the appropriate aperture value is 5.6, it becomes 2 when the ND filter is on.

Setting the Auto Rotate Function

This camera is equipped with an Intelligent Orientation sensor that detects the orientation of an image shot with the camera on end and automatically rotates it to the correct viewing orientation in the display. You can set this function on/off.



1 Select [Auto Rotate] in the [M] (Set up) menu.

- See Selecting Menus and Settings (p. 42).



2 Select [On] and press the **MENU** button.

- When this function is on, an icon showing the orientation of the camera appears at the upper right corner of the LCD monitor display (when information display is on).

	Normal
	Camera on right end
	Camera on left end



- This function may not operate correctly when the camera is pointed straight up or down. Check that the arrow is pointed in the right direction and if it is not, then set the Auto Rotate function to Off.
- Even if the Auto Rotate function is set to on, the orientation of images downloaded to a computer will depend upon software used to download the images.



- When the camera is held on end to shoot, the Intelligent Orientation sensor judges the upper end to be “up” and the lower end to be “down”. It then regulates the optimal white balance and exposure for vertical photography. This function operates regardless of the On/Off status of the Auto Rotate function.
- When changing the camera's orientation between the horizontal and vertical positions, you may hear noise coming from the orientation detection mechanism. This is not a malfunction.

Resetting the File Numbers

You can select the way file numbers are assigned.

On	The file numbers are reset to the start (100-0001) each time a new CF card is inserted. New images recorded on CF cards with existing files are assigned the next available number.
Off	The file number of the last image to be shot is memorized so that images recorded to a new CF card start from the next number.

1 In the **[M] (Set up)** menu, select **[File No. Reset]**.

- See *Selecting Menus and Settings* (p. 42).



2 Select **[On]** or **[Off]** and press the **MENU** button.



- Setting the **[File No. Reset]** to **[Off]** is useful for avoiding file name duplication when images are downloaded to a computer.

About File Numbers

- Images are assigned file numbers from 0001 to 9900 and organized in folders usually containing up to 100 images. Folders are assigned numbers from 100 to 998.

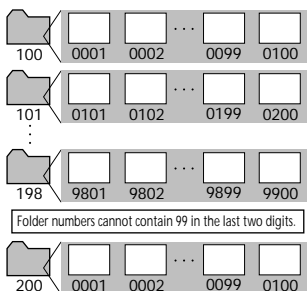

Since images shot in continuous mode or Stitch Assist mode are always saved in the same folder, some folders may contain 101 or more images.

Displaying Images Individually

You can view the recorded images on the LCD monitor.

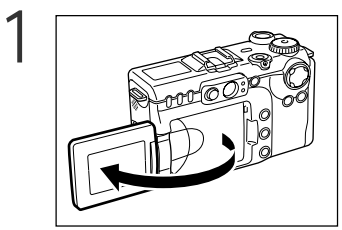

- Open the LCD monitor.
- The LCD monitor can be freely opened to any position (p. 32).

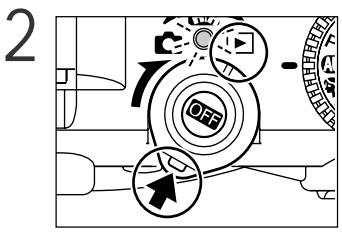

- Turn the mode lever to .
- The last recorded image appears (single image replay).

3 Move between images turning the main dial or using the ◀ or ▶ arrow on the omni selector.

- Use ◀ to move to the previous image and ▶ to move to the next. Holding ◀ or ▶ moves more rapidly between images, but the images will not appear as clearly.
- Turn the main dial to the left to move to the previous image and to the right to move to the next.
- Turn the main dial or press the ◀ or ▶ arrow on the omni controller after having pressed the **JUMP** button, to jump 10 images behind or ahead. If you press the **JUMP** button once more, the camera returns to the single image replay screen.



.....





- Press the **DISPLAY** button to show the data for the displayed image (p. 33).
- Press the  button to quickly delete the displayed image (p. 129).
- You can change the display language on the LCD monitor if you press and hold the **SET** button then press the **JUMP** button (p. 26). (This function cannot be used while a Direct Print compatible printer (optional) or the Direct Print compatible Bubble Jet Printer is connected to the camera.)

Magnifying Images

Images can be magnified up to approximately 10 times.

1 Turn the mode lever to .

2 Turn the zoom lever toward the  symbol.

- Press the ◀, ▶, ▲ or ▼ arrows on the omni selector to move the magnified area around the image.
- Press the zoom lever toward  while holding the **SET** button to cycle through each setting, approximately 2.5 times, to approximately 5 times and 10 times.



Approximate position

Canceling the Magnified Display

1 Turn the zoom lever toward the  symbol.

- When you press the  button, the magnified display is cancelled.



- Movie frames and index replayed images cannot be magnified.



- You can magnify an image while it is displayed on the LCD monitor in Shooting mode immediately after the image is shot (p. 53).



Viewing Nine Images at a Time (Index Replay)

Up to nine images can be viewed at once in index replay.

1 Turn the mode lever to .

2 Press the .

- Nine images appear at once (index replay).
- The same display appears even if you press the zoom lever once toward .

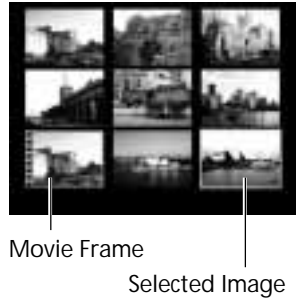



3 Change the image selection by turning the main dial or using the ▲, ▼, ◀ or ▶ arrow on the omni selector.



← Pressing the ▲ arrow in this row displays the previous set of nine images.

← Pressing the ▼ arrow in this row displays the next set of nine images.

4 Press the .

- Index replay cancels and the display reverts to single image replay.
- The same display appears even if you press the zoom lever once toward .



• Press the **DISPLAY** button to show the data for the displayed image (p. 33).

JUMP Jumping Between Images

The display can be advanced or set back 9 images in either single image replay or index replay.

1 Press the **JUMP** button while in single replay (p. 113) or index replay (p. 115).

- The jump bar appears.

2 The displayed image(s) change.

Single Replay

- Jump 9 images behind or ahead by turning the main dial or using the ◀ or ▶ arrow on the omni selector.



Jump Bar

Index Replay

- Jump to the previous or next set of nine images by turning the main dial or using the ◀ or ▶ arrow on the omni selector.



Jump Bar

3 Press the **JUMP** button.



- The jump bar disappears and the jump mode cancels.

Viewing Movies





You can replay the images shot in  mode.

- 1 Turn the mode lever to .

 - Movies cannot be viewed in index replay.

- 2 Select a movie by turning the main dial or by using the  or  arrow on the omni selector and press the **SET** button.
 - A movie displays with the instruction  on it.
 - The movie replay panel appears.





- 3 Select  (Replay) using the  or  arrow on the omni selector and press the **SET** button.
 - The movie images and sound will play.
 - You can adjust the volume using the  or  arrow on the omni selector.
 - When a movie has finished playing, it will display the last frame. If the **SET** button is pressed in this state, the camera will revert to the movie replay display. If the **SET** button is pressed again, the movie will start playing from the first frame.



Pausing and Resuming Play

- Press the **SET** button to pause the movie. Press it again to resume.

Fast Forwarding / Rewinding

- Select one of the following operations using the  or  arrow on the omni selector and press the **SET** button.

 : Return to Single Image View

 : First Frame

 : Previous Frame (Rewinds if the **SET** button is held down)

 : Next Frame (Fast-forwards if the **SET** button is held down)

 : Last Frame

Viewing Movies (continued)



- You may experience frame dropping and audio breakup when replaying a movie on a computer with insufficient system resources.



- The volume at which movies replay can also be adjusted in the Replay menu (p. 163).
- Please adjust the audio sound level on the TV when viewing movie files on a TV.



Editing Movies

You can delete unwanted portions from the first or second half of a movie clip.

- 1 Select the movie you wish to edit and press the **SET** button.
 - See Viewing Movies (p. 117).

- 2 Select  (Edit) using the ◀ or ▶ arrow on the omni selector and press the **SET** button.
 - The movie editing panel and the movie editing bar appear.



- 3 Select an editing method using the ▲ or ▼ arrow on the omni selector.
 -  : Deletes frames in the first half of the movie
 -  : Deletes frames in the second half of the movie
 -  : Reverts to movie editing panel

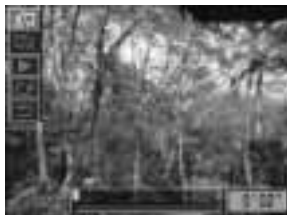

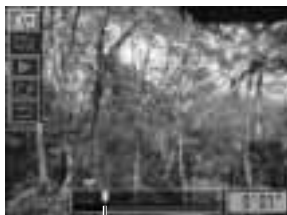

- 4 Select the range you wish to edit using the ◀ or ▶ arrow on the omni selector.



Editing position

- 5 Select  (replay) using the ▲ or ▼ arrow on the omni selector and press the **SET** button.
 - The temporarily edited movie will start playing.
 - The movie will pause if you press the **SET** button while it is playing.

6 Select  (save) using the ▲ or ▼ arrow on the omni selector and press the **SET** button.

- When  is selected, the edited movie is not saved and the camera reverts to the movie editing panel.



7 Select [Overwrite] or [New File] using the ◀ or ▶ arrow on the omni selector.

- [Overwrite] : Saves the edited movie under the same file name as the original movie. The original data is deleted.
- [New File] : Saves the edited movie under a new file name. The original data is not deleted.
- When there is not enough space left on the CF card, only the overwrite function is available. If this happens, ▲ appears in the time display on the movie.



- Protected movies cannot be edited.
- It may take approximately 3 minutes to save an edited movie. If the battery pack runs out of charge partway through, edited movie clips cannot be saved. When editing movies, use a fully charged battery pack or the Compact Power Adapter CA-560 (p. 21).



- Movies with an original length of 2 seconds or more can be edited.
- The minimum length for movie clips is 1 second.

Rotating Images in the Display

Images can be rotated 90° and 270° clockwise on the LCD monitor.

Original



90°



270°



1 Select [Rotate] from the [▶] (Replay) menu.

- See Selecting Menus and Settings (p. 42).



2 Select an image you want to rotate by turning the main dial or by using the ◀ or ▶ arrow on the omni selector and press the **SET** button.

- The image cycles to the next orientation (90° → 270° → original) each time the **SET** button is pressed.

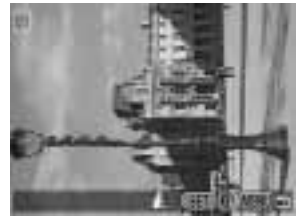

3 Press the **MENU** button.

- The Replay menu appears again. Press the **MENU** button again to close the menu.



- Movie images cannot be rotated.
- When images are downloaded to a computer, the orientation of images rotated by the camera will depend upon the software used to download the images.



- Images can be magnified when rotated (p. 114).
- Images taken vertically with the auto rotate function (p. 111) set to [On] will automatically be rotated to the vertical position when viewed on the LCD monitor.

Attaching Sound Annotations to Images

In replay mode (including single replay, index replay, magnifying replay and the replay immediately after shooting in Shooting mode) you can attach sound annotations (up to 60 seconds) to an image. The sound data is saved in WAVE format.

- 1 Press the  button while replaying images.
 - The A / V panel appears.



- 2 Select  using the ◀ or ▶ arrow on the omni selector, then press the **SET** button.

- The recording starts and the elapsed time is displayed. Speak towards the microphone of the camera.
- To stop recording, press the **SET** button. To restart recording, press the **SET** button again.
- You can add as many sound annotations as you like until their total time reaches 60 seconds.



Playing back the Sound Annotations

Select  in step 2 above. Images with sound annotations are displayed with the  mark (Simple Display or Detailed Display). To start playback, press the **SET** button. To stop playback, press the **SET** button again. You can adjust the volume using the ▲ or ▼ arrow on the omni selector.

Erasing the Sound Annotations

Select  in step 2 above.



- You cannot attach sound annotation to movies.
- You cannot record or playback sound notes for images that already have an incompatible sound file attached. If you attempt to record or play an image with the  icon, the “Unidentified sound file” message will display. Incompatible sound files can be deleted with this camera.
- Sound annotations for protected images cannot be erased. (p. 128).



- The volume can be adjusted in the Set up menu (p. 163).

Automated Playback (Slide Show)

Slide show image settings are based on DPOF standards (p. 134).

Starting a Slide Show

All images or a selection of images on a CF card can be displayed one-by-one in an automated slide show.

All Images	Plays all the images on the CF card in order
Slide Show 1 - 3	Plays the images selected for each show in order.

1 In the [**▶**] (Replay)] menu, select [Slide Show] and press the **SET** button.

- See Selecting Menus and Settings (p. 42).

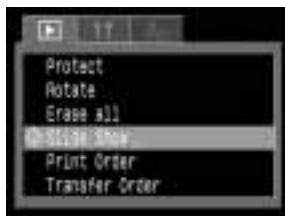

2 Press the **▲** or **▼** arrow on the omni selector to select [Program]. Press the **◀** or **▶** arrow to select between [All Images] or any one of slide [Show 1]-[Show 3].



3 Press the **▲** or **▼** arrow on the omni selector to select [Start] and press the **SET** button.

- The slide show will start and automatically stop when the show is done.

Pausing and Resuming a Slide Show

- Press the **SET** button to pause the show. Press it again to resume.

Fast Forward / Rewinding a Slide Show

- Turn the main dial or use the **◀** or **▶** arrow on the omni selector to move to the previous or next image.

Stopping a Slide Show

- Press the **MENU** button during a slide show to stop it and display the slide show menu.

4 When the slide show is over, press the **MENU** button.

- The slide show menu appears again. Press the **MENU** button again to close the menu.



- Movie images play for the length of time that they were recorded regardless of the time set in the slide show settings.
- The power-saving function is disabled while a slide show plays on the camera (p. 30).

Selecting Images for Slide Shows

You can mark images for inclusion in slide shows 1-3. Up to 998 images may be marked per slide show. Images display in the order of their selection.

1 Display the slide show menu (p. 124).

2 Press the ▲ arrow on the omni selector to select [Program]. Press the ◀ or ▶ arrow to select [Show 1], [Show 2] or [Show 3].

- A check mark will appear beside a show already containing images.

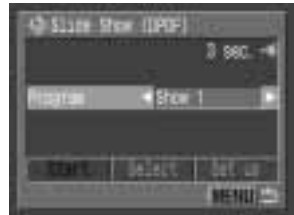

3 Press the ▼, and ◀ or ▶ arrow on the omni selector to choose [Select] and press the **SET** button.

4 Mark images to include in the show.
Single Replay

- Move between images using the main dial or the ◀ or ▶ arrow on the omni selector and mark or remove marks from images using the ▲ or ▼ arrow on the omni selector.
- The selection number and a check mark appear at the top of selected images.



Index Replay

- Press the  button to switch to index replay (3 images).
- Select an image using the main dial or the ◀ or ▶ arrow on the omni selector and mark or remove marks from images using the ▲ or ▼ arrow on the omni selector.
- The selection number and a check mark appears at the bottom of selected images.

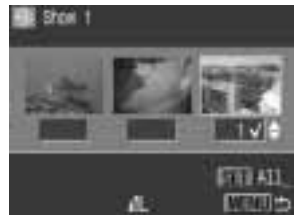

Automated Playback (Slide Show) (continued)

- After you press the **SET** button, you can select all the images by selecting [Mark all] using ▲ or ▼ on the omni selector and pressing the **SET** button again. (You can deselect all the images by selecting [Clear all].)
- You can select images using the main dial or the ◀ or ▶ arrow on the omni selector and change the settings using the ▲ or ▼ arrow on the omni selector after [Mark all] or [Clear all] has been selected.

- 5 Press the **MENU** button.
 - The image selection screen will close.

Adjusting the Play Time and Repeat Settings

You can change the play time for all the images in a show and have the show repeat itself continuously.

Play Time	Sets the duration that each image in a slide show is displayed. The options are any one of 3-10 seconds, 15 seconds, 30 seconds and Manual.
Repeat	Sets whether the slide show stops when all the slides have been displayed or continues to display until stopped.

- 1 Display the slide show menu.
- 2 Select [Set up] using the ◀ or ▶ arrow on the omni selector and press the **SET** button.
- 3 Select [Play Time] or [Repeat] using the ▲ or ▼ arrow on the omni selector.



4 Select a setting using the ◀ or ▶ arrow on the omni selector.

Play Time

- Select a play time.



Repeat

- Select [On] or [Off].



5 Press the **MENU** button.

- The set up menu closes.





- The display interval may vary somewhat for some images.
- Slide shows can be easily edited on a computer with the supplied software. See the Software Starter Guide.

Protecting Images

You can protect important images from accidental erasure.

- 1 In the [ (Replay)] menu, select [Protect] and press the **SET** button.
 - See Selecting Menus and Settings (p. 42).



- 2 Select an image you want to protect by turning the main dial or by using the ◀ or ▶ arrow on the omni selector and press the **SET** button.
 - The  icon appears on protected images.
 - To remove the protection, press the **SET** button again (in protection mode).
 - You can make the selection of images easier by toggling between single replay and index replay with the  button.



- 3 Press the **MENU** button.
 - The protect window closes.



- Please note that formatting (initializing) a CF card erases all data, including protected images (p. 131) and other file types. Please check the contents of a CF card before formatting it.

Erasing Images Individually



- Please note that erased images cannot be recovered. Exercise caution before erasing a file.

1 Set the camera to the replay mode (p. 29).

2 Select the image you wish to erase by turning the main dial or by using the ◀ or ▶ arrow on the omni selector and press the  button.

3 Select [Erase] using the ◀ or ▶ arrow on the omni selector and press the **SET** button.

- To cancel instead of erasing, select [Cancel] and press the **SET** button.



Replaying, Erasing



- Protected images cannot be erased with the erase function (p. 128).

Erasing All Images



- Please note that erased images cannot be recovered. Exercise caution before erasing a file.

1 In the [ (Replay)] menu, select [Erase all] and press the **SET** button.

- See Selecting Menus and Settings (p. 42).



2 Press the ◀ or ▶ arrow on the omni selector to select [OK] and press the **SET** button.

- To cancel instead of erasing, select [Cancel] and press the **SET** button.



- Protected images cannot be erased with the erase function (p. 128).

Formatting a CF Card

You should format a new CF card or one from which you wish to erase all images and other data.

Formatting may restore a CF card if it returns an error or if the “CF” message displays.



- Please note that formatting (initializing) a CF card erases all data, including protected images and other file types. Please check the contents of the CF card before formatting it.

1 In the **[M]** (Set up) menu, select [Format] and press the **SET** button.

- See Selecting Menus and Settings (p. 42).

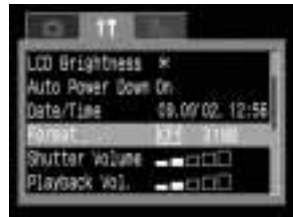

2 Press the ◀ or ▶ arrow on the omni selector to select [OK] and press the **SET** button.

- To cancel formatting instead, select [Cancel] and press the **SET** button.



- If the camera does not work properly, the inserted CF card may be malfunctioning. Reformatting the CF card may solve the problem.
- When a non-Canon brand CF card is malfunctioning, reformatting it may solve the problem.
- CF cards formatted in another camera, computer or peripheral device may not operate correctly. When that happens, reformat the CF card with this camera.

Printing

About Printing

This camera supports direct printing. By connecting the camera to an optional printer or Bubble Jet printer (sold separately) that supports the direct print function, you can send the images from the CF card directly to the printer using the camera buttons. Or, you can specify the images on your CF card you want to print and how many copies you want (DPOF* Print Settings), and then take the CF card to a participating photo lab to have them printed out later.

* Digital Print Order Format

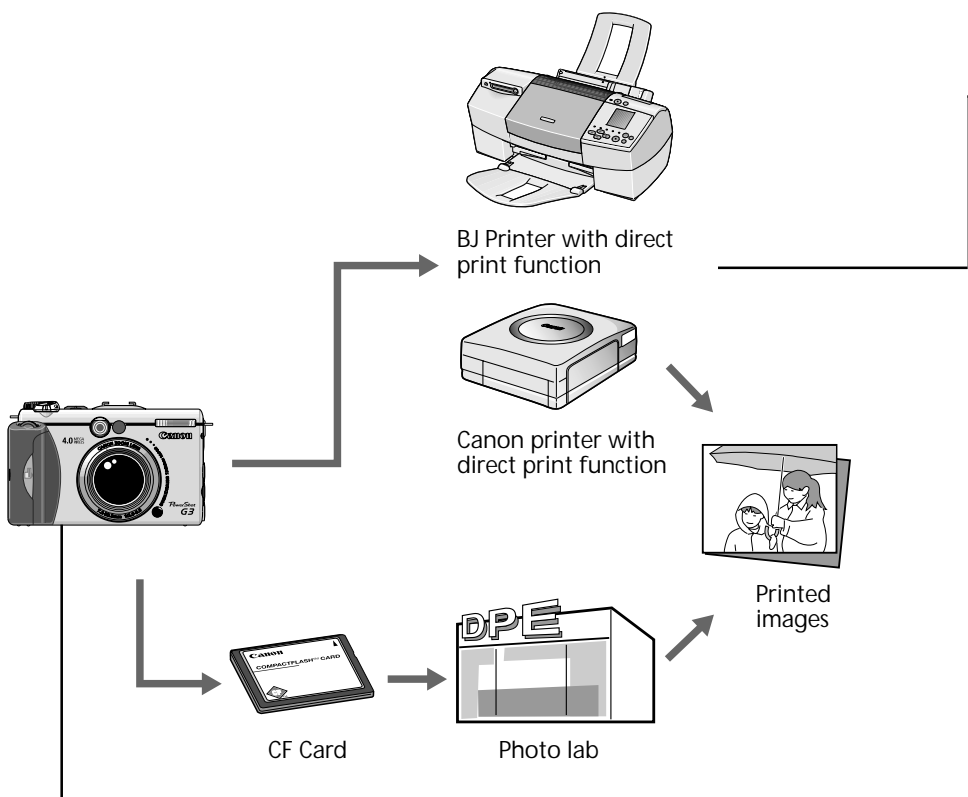

Please refer to the System Map supplied with your camera for direct print function compatible printer information.

Print Settings for Direct Print Function

- Select how many copies you want (p.141)
↓
- Select the print style (p.141)
 - Standard / Multiple (Direct Print Function Compatible Printer)
 - Paper : Card #1 / Card #2 / Card #3 / LTR / A4 (Direct Print Function Compatible BJ Printer)
 - Bordered / Borderless
 - Date On / Off
↓
- Select the print area (Trimming) (p.143)

DPOF Print Settings

- Select the image you want to print (p. 145)
↓
- Select how many copies you want (p. 146)
↓
- Select the print style (p. 147)
 - Standard / Index
 - Date On / Off
 - File Numbers On / Off

DPOF Transfer Order

- Select the image you want to send through e-mail* (p. 152)
* The DPOF-compliant software is needed for actually transferring the images.

Selecting from the Print Menu

Use the Print menu as shown below to select all print settings. However, set the camera to replay mode beforehand.

Direct Print Function



DPOF Settings

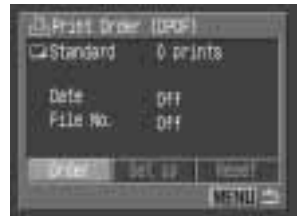



: Turns the menu on/off



: Selects items and settings



: Sets items and settings

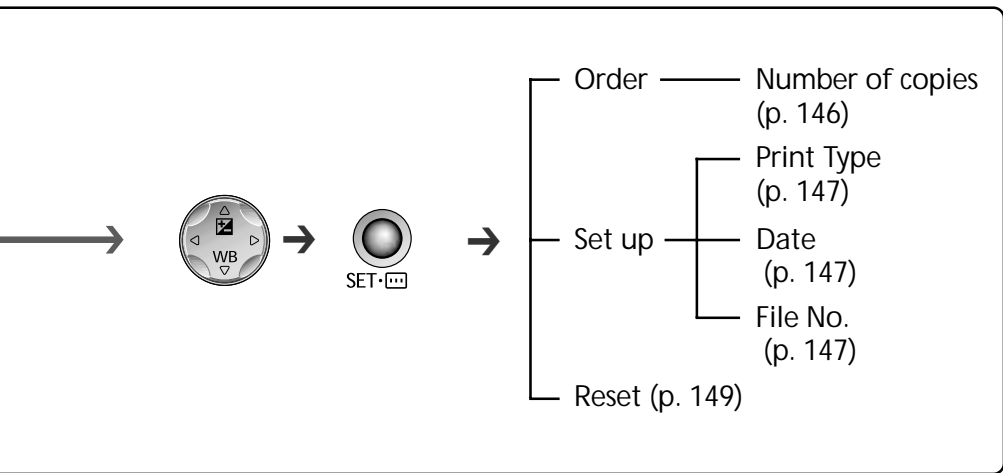
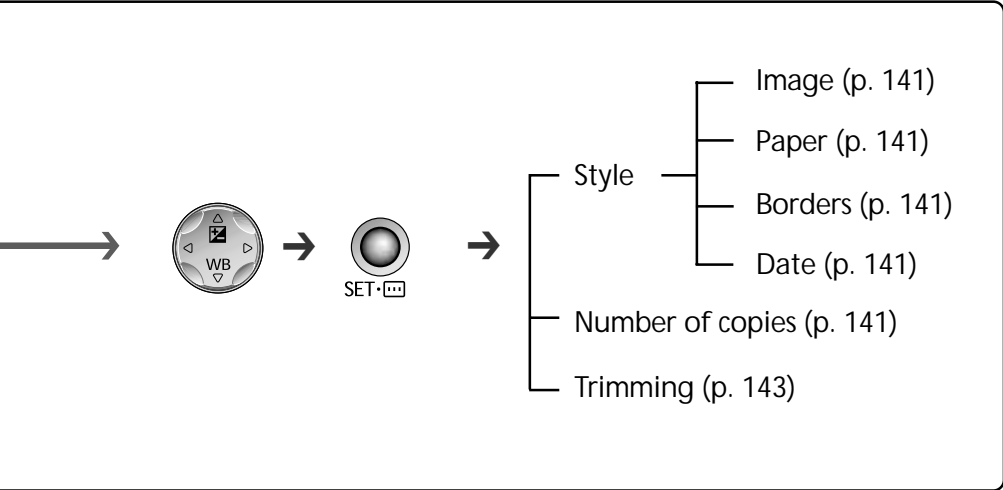

Connecting the Camera to a Printer

You can make clear prints swiftly and easily when you connect the camera to a direct print function compatible printer (optional) or a direct print function compatible Bubble Jet printer (optional). It can also be used with DPOF print settings.



- You are recommended to use the Compact Power Adapter CA-560 to power the camera when it is connected to the printer. If you are using a battery pack, ensure that it is fully charged.



- Refer to the System Map included with this camera kit for printer information.
- Please see your printer's user guide for instructions on loading paper and installing ink cassettes / tanks.

Connecting to a Direct Print Function Compatible Printer

Two direct interface cables are supplied with the printer. Use the cable (DIF-100) that has a ⇐ Symbol on the connector to connect to this camera.

1 Turn off the camera (p. 29).

2 Attach the power cable to the printer and plug the other end into power supply, or, install the printer's rechargeable battery.

- Depending on the type of printer you have, it may or may not use rechargeable batteries. Refer to your printer's user guide.

3

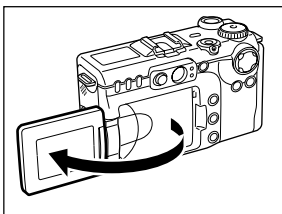

Open the LCD monitor.

4

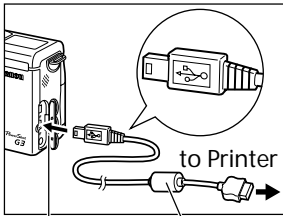

DIGITAL Terminal
Direct Interface Cable DIF-100

Connect the camera and printer using the direct interface cable.

- When you insert the cable, make sure the ← mark of the cable faces the front of the camera.

5

Press the printer's ON/OFF button to turn on the power.

- When the printer is properly connected to the camera, it powers up,  appears on the camera LCD monitor and the power/mode indicator is lit in green.
- With the Card Photo Printer CP-10, the power turns on when the power cord is connected to the printer as shown in Step 2.



Connecting to a Bubble Jet Printer



-
- Please read the user guide supplied with your BJ printer to see if it is compatible with the direct print function, and for instructions on connection cables and general operations.

1

Turn off the camera (p. 29).

2

Turn the BJ printer's power on after you have connected the power cord to the BJ printer and inserted the other end in a power outlet.

3

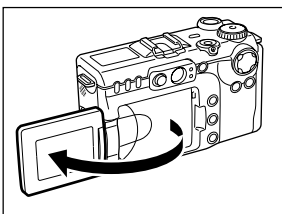

Open the LCD monitor.

Connecting the Camera to a Printer (continued)

4

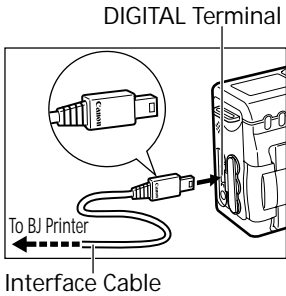

Connect the camera and printer using the cable.



- When you insert the cable, make sure the “Canon” logo on the cable faces the back of the camera (LCD monitor side).

-  appears on the camera LCD monitor and the power/mode indicator is lit green when the printer is properly connected to the camera.



- When you detach the cable from the camera, hold the plug and do not pull by the cable.



- The following operations cannot be performed while the printer is connected.
 - Replaying movies
 - Setting the language using the **SET** and the **JUMP** button combination.
- When the printer is disconnected, the  or  symbol will disappear from the LCD monitor and the camera will revert to standard replay mode.

Printing

The following illustrations show examples from a direct print function compatible printer. Options for the Style category will differ slightly for BJ printers.

An image can be printed when displayed in single replay or selected in index replay.

1 Choose an image by turning the main dial or by using the ◀ or ▶ arrow on the omni selector and press the **SET** button.

2 Set the number of prints, the print style and cropping settings as required.

- *Selecting the Number of Copies* (p. 141)
- *Setting the Print Style* (p. 141)
- *Trimming (Printing a Portion of an image)* (p. 143)

3 Press the ▲, ▼, ◀ or ▶ arrows on the omni selector to choose [Print] and press the **SET** button.

- You can also select [Print] by pressing the **JUMP** button.
- The image will start to print and, when it is completely finished, the display will revert to standard replay mode.





- You cannot print movies or images recorded in the RAW format.



Cancel Printing

- To cancel printing between images, press the **SET** button. A confirmation dialog will display. Press the ◀ or ▶ arrow to select [OK] and press the **SET** button.
 - Direct Print Function Compatible Printers
 - A print in progress cannot be stopped. The printer will stop after the current print is complete and the camera will display its replay screen at that point.
 - BJ Printers
 - The printer will stop printing the current image and eject the paper.

Printing Errors

- An error message will display if an error occurs for some reason during the printing process. Press the ◀ or ▶ arrow on the omni selector to choose [Stop] or [Resume] and press the **SET** button (with a BJ printer, printing resumes automatically once the problem is solved).
 - Direct Print Function Compatible Printers
 - The [Resume] option may not appear with some types of errors. In that case, select [Stop].
 - BJ Printers
 - The [Continue] and [Stop] options may appear with some error messages.
 - The error number is displayed on the operation panel of Bubble Jet Printer. Please refer to the Bubble Jet Printer Quick Start Guide for the remedies corresponding to the error numbers.

Setting the Print Settings (Direct Print Function)

Selecting the Number of Copies

- 1 In replay mode, press the **SET** button and the ▲ or ▼ arrow on the omni selector to select the [Copies] option.



- 2 Press the ◀ or ▶ arrow on the omni selector to specify the desired number of copies.
 - You can specify from 1 to 99 prints.

Setting the Print Style

You can select from among the following print styles.

Direct Print Function Compatible Printer

Image	Standard	Prints one image per page.
	Multiple*	Prints eight copies of the same image on one page.
Borders	Borderless	Prints right to the edges of the page.
	Bordered	Prints with a border.
Date		Prints the image's creation date.

* Only selectable when printing with credit-card size paper.

Direct Print Function Compatible BJ Printer

Paper		Select the paper size from the following. [Card #1], [Card #2], [Card #3], [LTR] or [A4] For the usable paper type, please refer to the Bubble Jet Printer User Guide.
Borders	Borderless	Prints right to the edges of the page.
	Bordered	Prints with a border.
Date		Prints the image's creation date.

Setting the Print Settings (Direct Print Function) (continued)

- 1 In the print setting menu, choose [Style] using the ▲ or ▼ arrow on the omni selector and press the **SET** button.



- 2 Choose [Image] (or [Paper], [Borders] or [Date]) using the ▲ or ▼ arrow on the omni selector.



- 3 Press the ◀ or ▶ arrow on the omni selector to set the selection.

 Image Settings
(Direct print function
compatible printer)



Select [Standard] or
[Multiple].

 Paper
(BJ printer)



Select [Card #1], [Card #2],
[Card #3], [LTR] or [A4]

 Borders



Choose [Borderless] or
[Bordered].

 Date

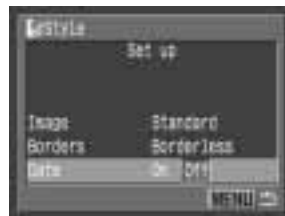

Choose [On] or [Off].

4 Press the **MENU** button.

- With borderless or multiple prints, the top, bottom and sides of the image may be cropped slightly. If you have not specified a trimming setting, a frame will appear around the area of the image that will be printed, allowing you to check the portion that will be cropped.



Print Area Frame



- The date settings are overridden by the DPOF settings if you are using them to print (p. 145).
- When printing multiple prints, the borders and the date cannot be set. (Images are printed without any date or borders)
- With the [Bordered] option, the border is printed in practically the same space as the recorded image.

Setting the Printing Area (Trimming)

You can specify which portion for an image gets printed.



Prior to Trimming

Please set the Print Style (Image Settings, Paper, Borders and Date) first before setting the trimming settings (p. 141).



1 In replay mode, press the **SET** button and the **▲** or **▼** arrow on the omni selector to choose [Trimming] and press the **SET** button again.

- The trimming frame will appear at the center of the image. If a trimming setting has already been selected for the image, the frame will appear around the previously selected portion.







2 Trim the Image.

Changing the Size of the Trimming Frame

- Move the zoom lever toward the  or  symbol.
- The trimming frame can be changed to a minimum selection of approximately half the displayed image or a maximum selection that is virtually the same size as the image.
- You can cancel the trimming setting by moving the zoom lever toward the  symbol again when the trimming frame is already set to the maximum size.
- When printing an image that has been magnified using the trimming option, the image quality may become coarser and grainier depending on the magnifying rate. With direct print function compatible printers, the trimming frame displays in red.



Setting the Portion of the Trimming Frame

- Press the , ,  or  arrows on the omni selector to move the trimming frame.

Rotating the Trimming Frame

- You can rotate the trimming frame by pressing the **DISPLAY** button.

3 Press the **MENU** button to close the setting menu.



Trimming Frame



- The trimming setting only applies to one image.
- The trimming setting is cancelled with the following operations.
 - When you set the trimming settings for another image.
 - When you close the Print mode (when you turn the camera power off, change the camera mode, or detach the direct interface cable).
 - When you try to expand the trimming frame beyond its maximum size.



- The selected Image Settings, Paper and Border settings determine the shape of the trimming frame.
- Please use the LCD monitor to set the trimming settings. The trimming frame may not display correctly on a TV monitor.

Print Settings (DPOF Print Settings)

You can select images on a CF card for printing and specify the number of print copies in advance using the camera. This is extremely convenient for sending the images to a photo developing service or for printing on a direct print function compatible printer or a direct print function compatible BJ printer.

.....





- The  mark appears on images that have had print marks set by another DPOF-compliant camera. These settings will be overwritten by any print marks set by your camera.
- Print settings cannot be set for movie images or RAW images.
- The output of some digital printers or photo lab services may not reflect the specified print settings.

Selecting Images for Printing

- 1 In the [ (Replay)] menu, select [Print Order] and press the **SET** button.
 - See *Selecting Menus and Settings* (p. 42).



- 2 Press the  or  arrow on the omni selector to select [Order] and press the **SET** button.



3 Select images for printing.

Single Images

- When the print type (p. 147) is set to [Standard] or [Both], select an image using the main dial or the ◀ or ▶ arrow on the omni selector. You can set the number of copies (up to 99) to be printed using the ▲ or ▼ arrow on the omni selector.
- When the print type (p. 147) is set to [Index], select an image using the main dial or the ◀ or ▶ arrow on the omni selector and mark or remove marks from images using the ▲ or ▼ arrow on the omni selector.
- You can use the same procedures to select images in index replay (3 images). Press the  button to switch between single replay and index replay.

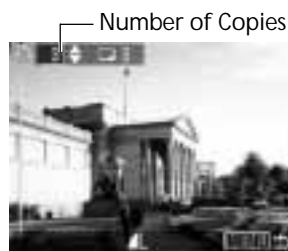

All the Images on a CF Card

- Press the  button to switch to index replay (three images).
- You can set one copy of each image to print by pressing the **SET** button, then selecting [Mark all] using the ▲ or ▼ arrow on the omni selector, and pressing the **SET** button again.
- When the print type is set to [Standard] or [Both], the setting for the number of print copies can be changed for each image. When [Index] is selected, the print settings can be deleted. For the instructions on changing settings, please reread Step 3 from the beginning.
- You can cancel all the settings by selecting [Clear all].



4 Press the **MENU** button.

- The selection mode will turn off and the Print Order menu will reappear.



- Images are printed in order from oldest to newest by the shooting date.
- A maximum of 998 images can be marked per CF card.
- When [Print Type] is set to [Both], the number of copies can be set. When it is set to [Index], the number of copies cannot be set (only one copy will be printed).
- Print settings can also be assigned to images with the supplied software programs on a computer.

Setting the Print Style

Always select a print style after having selected the image you wish to print.

The following print settings can be selected.

Print Type	<input checked="" type="radio"/> Standard	Prints one image per page
	<input type="radio"/> Index	Prints the selected images together at a reduced size in an index format
	<input type="radio"/> <input type="radio"/> Both	Prints the images in both the standard and index formats
Date		Adds the date to the print
File No.		Adds the file number to the print

1 In the  (Replay) menu, select [Print Order] and press the **SET** button.

- See *Selecting Menus and Settings* (p. 42).



2 Press the ◀ or ▶ arrow on the omni selector to select [Set up] and press the **SET** button.



3 Press the ▲ or ▼ arrow on the omni selector to select [Print Type], [Date] or [File No.]

4 Press the ◀ or ▶ arrow on the omni selector to select a setting.

Print Type

- Select [Standard], [Index] or [Both].



Date

- Select [On] or [Off].

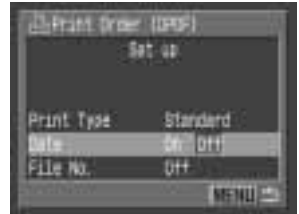

File No.

- Select [On] or [Off].



5 Press the **MENU** button.

- The set up menu will close and the Print Order menu will reappear.



- When [Print Type] is set to [Index], the [Date] and [File No.] cannot be set to [On].
- If [Print Type] is set to [Both], both [Date] and [File No.] can be set to [On], however, only the file number is printed for the index print.



- The date prints as the date and time in the format specified in the Set Date/Time menu (p. 24).

Resetting the Print Settings

The print settings can all be removed at once. The print type is reset to [Standard] and the date and file number options are set to [Off].

- 1 In the [▶] (Replay) menu, select [Print Order] and press the **SET** button.
 - See *Selecting Menus and Settings* (p. 42).



- 2 Press the ◀ or ▶ arrow on the omni selector to select [Reset] and press the **SET** button.



- 3 Press the ◀ or ▶ arrow on the omni selector to select [OK] and press the **SET** button.

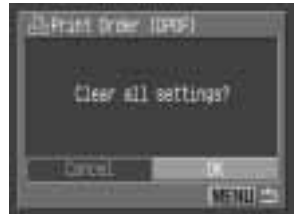

Printing with DPOF Print Settings

You can use the DPOF print settings to print with a direct print compatible printer (optional) or with a direct print function compatible BJ printer.

1 In the [ (Replay)] menu, select [Print Order] and press the **SET** button.

- See *Selecting Menus and Settings* (p. 42).



2 Press the ▲, ▼, ◀ or ▶ arrows on the omni selector to select [Print] and press the **SET** button.



3 Set the print style settings as required.

- See *Setting the Print Style* (p. 141).
- A print style cannot be set if the print type is set to [Index] in the DPOF print setting. (You can also select the type of paper when printing with a BJ printer)

4 Press the ▲, ▼, ◀ or ▶ arrows on the omni selector to select [OK] and press the **SET** button.

- The image will start to print and, when it is completely finished, the display will revert to the standard replay mode.





- To print the date, set the [Date] setting in the print order menu in Step 2 on the previous page to [On]. You cannot set the date to print with the [Style] menu in Step 3 on the previous page. If the print type is set to [Index], the date will not print even if the [Date] setting is set to [On] in Step 2.
- When the print type is set to [Both], it is possible to have both the [Date] and [File No.] options set to [On], but only the file number will print on the Index print. (With a BJ printer, the file number and the date cannot be printed in the [Index] option)
- When the print type is set to [Standard], file numbers will not be printed even if they are set to [On].



- The maximum number of images printed on one page in the Index print type depends upon the selected paper size.
 - Card Size: 20 images
 - L Size: 42 images
 - Postcard Size: 63 images(Please refer to your Bubble Jet's user guide for an explanation of the number of images printed with a Bubble Jet printer.)

Cancel Printing (p. 140)

Restarting Printing

- In the Print Order menu, press the ◀ or ▶ arrow on the omni selector to select [Resume] and press the **SET** button. The remaining images can be printed.
- Printing cannot be restarted under the following circumstances.
 - If the print settings have been changed before restarting.
 - If the image for which the print settings were set has been deleted before restarting.
 - If there was very little free space on the CF card when the printing was cancelled.

If these circumstances apply, you can select [OK] in the Print Order menu and reprint starting from the first image. If printing was cancelled because the camera battery became discharged, you are recommended to power the camera with the Compact Power Adapter CA-560. If you must use a battery pack, ensure that it is fully charged for printing. After replacing the spent battery pack, turn the camera power on again.

Printing Errors (p. 140)

Image Transfer Settings (DPOF Transfer Order)

Using the camera, you can make marks on images you wish to transfer and attach to e-mails. (Please use the supplied software for actually transferring images. Refer to the *Software Starter Guide* for instructions on how to transfer images.) These settings are compatible with the Digital Print Order Format (DPOF) standards.



- The  mark will display on images that have had transfer marks set by another DPOF-compliant camera. These settings will be overwritten by any marks set by your camera.

Selecting Images for Transferring

1 In the [ (Replay)] menu, select [Transfer Order] and press the **SET** button.

- See *Selecting Menus and Settings* (p. 42).



2 Select [Order] using the ◀ or ▶ arrow on the omni selector and press the **SET** button.

- Pressing [Reset] cancels the transfer settings for all images on the CF card.



3 Select images for transferring.

Single Images

- Select an image using the main dial or the ◀ or ▶ arrow on the omni selector and mark or remove marks from images using the ▲ or ▼ arrow on the omni selector.
- You can use the same procedures to select images in index replay (3 images). Press the  button to switch between single replay and index replay.



All the Images on a CF Card

- Press the  button to switch to index replay (three images).
- Then press the **SET** button, and select [Mark all] using the ▲ or ▼ arrow on the omni selector and press the **SET** button again. (If you select [Clear all] instead of [Mark all], you can remove marks from all the images.)
- You can select images using the main dial or the ◀ or ▶ arrow on the omni selector and change the settings using the ▲ or ▼ arrow on the omni selector after [Mark all] or [Clear all] has been selected.



4 Press the **MENU** button.

- The selection mode will turn off and the Transfer Order menu will reappear.



- Images are transferred in order from oldest to newest by the shooting date.
- A maximum of 998 images can be marked per CF card.
- Transfer settings can also be assigned to images with the supplied software programs on a computer.

Viewing Images on a TV Set

A video-compatible television connected via the supplied AV cable AVC-DC100 can be used to view images as you shoot or replay them.

1 Turn off the camera (p. 29).

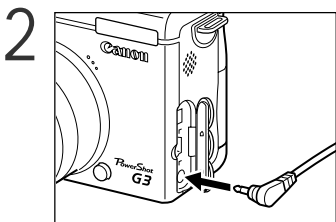

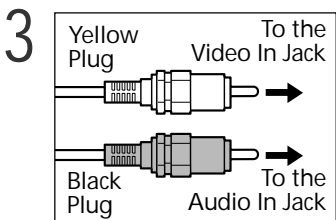

Attach AV Cable AVC-DC100 to the **A/V OUT** terminal on the camera.



Plug the other ends of the AV cable to the video in and audio in jacks on the TV.

4 Turn on the TV and switch it to Video mode.

5 Turn the mode lever to  or  (p. 28, 29).

- The image will appear on the TV. Shoot or replay images as usual.
- If the images are not appearing on the TV when shooting, press the **DISPLAY** button.



- No image will appear on the LCD monitor when the camera is connected to a TV monitor.
- The video output signal can be switched (NTSC or PAL) to accommodate different regional standards (p. 165). The default setting will vary between regions.
NTSC: Japan, U.S.A., Canada, Taiwan, etc.
PAL: Europe, Asia (excluding Taiwan), Oceania, etc.
If an incorrect video system is set, the output image will not display properly.
- If the TV is a stereo model, you can plug the audio plug into either the left or right Audio In jack. Please refer to the TV's manual for details.
- A TV monitor cannot be used in  mode.

Downloading Images to a Computer

Download images taken with the camera to a computer in one of the following ways:

- Directly from the CF card
- Connect the camera to a computer with the USB cable

You must install the software and USB driver bundled on the Canon Digital Camera Solution Disk before connecting the camera to the computer.

After installing the supplied software, download images automatically by simply connecting the camera to a computer with the supplied USB cable.

* For information about system requirements and for more details about how to install the software and download images, refer to the *Software Starter Guide*.

Downloading Directly from a CF Card

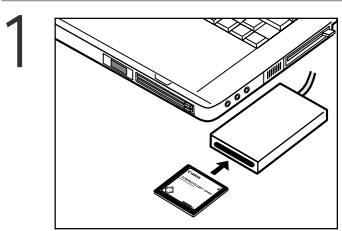

Eject the CF card from the camera, and insert it into a CF card reader connected to the computer.

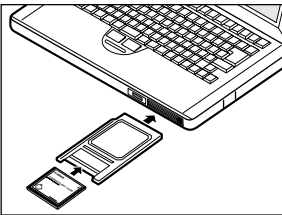

- If you are using a PC card reader, first insert the CF card into a PC card adapter (optional), and then insert the PC card adapter into the computer's PC card reader.

2 Double-click the icon of the drive with the CF card.

3 Copy images from the card into a folder of your choice on the hard disk.

- The images are stored in the [xxxCANON] folders located under the [DCIM] folder (where xxx is a three-digit number from 100 to 998).

.....



- Some computers or memory card readers require the power to be off when the CF card or PC card adapter is inserted. Since this requirement varies between models, please consult the manual for your equipment.

Connecting the Camera to a Computer Via the USB Cable

IMPORTANT

You must install the software and USB driver bundled on the Canon Digital Camera Solution Disk before connecting the camera to the computer. Please refer to the *Software Starter Guide* for installation instructions, image download instructions and system requirements.

- 1 Connect the supplied USB interface cable to the computer's USB port and the camera's **DIGITAL** terminal.
 - You do not need to turn off the computer or camera when making this connection.
 - Please refer to your computer manual for information regarding the location of the USB port.
 - The LCD monitor will blank out when the connection to the computer is complete and the power/mode indicator will light yellow.

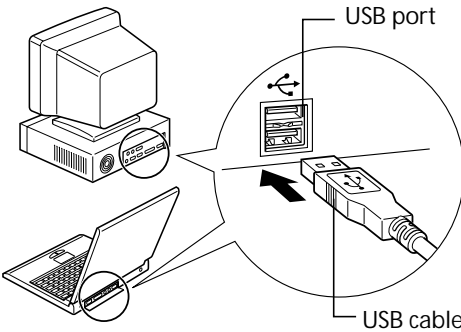

DIGITAL terminal

1. Open the terminal cover with your fingernail.
2. Insert the connector until it clicks.

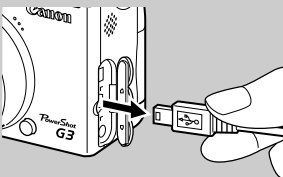
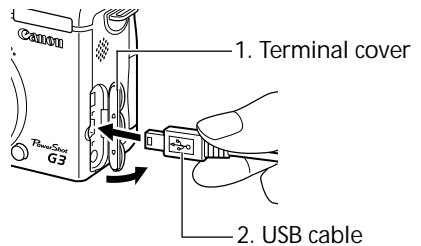

To disconnect the cable from the camera: Hold the cable connector firmly at both sides and pull it straight out.

Setting the Communication Mode

Sets the communication mode when downloading images with the camera connected to the computer.

Normal (Default)	Usual setting. You must install the USB driver bundled on the Canon Digital Camera Solution Disk before using this mode.
PTP (Picture Transfer Protocol)	The below functions are available even if the software and USB driver bundled on the Canon Digital Camera Solution Disk have not been installed. <ul style="list-style-type: none">• Viewing the camera's images• Downloading the camera's images to a computer• Deleting the camera's images These functions are available with Windows XP or Mac OS X (10.1) or a later OS*.

* With any other OS [PTP] cannot be used. Please select [Normal].

1 Check that the camera is not connected to the computer.

2 In the  (Set Up)] menu, select [Communication].

- See Selecting Menus and Settings (p. 42).



3 Select [Normal] or [PTP] using the ◀ or ▶ arrow on the omni selector and press the **MENU** button.

.....

 • Some problems may occur when downloading images to a computer in the PTP mode with certain file types. For more details, please refer to the supplied Picture Transfer Protocol (PTP) Mode leaflet.

.....

 • It is recommended to power the camera with the Compact Power Adapter CA-560 when connected to a computer (p. 21).

- If you disconnect the USB cable while the camera is on, the camera will automatically turn off.
- If you leave the camera unused for approximately 5 minutes while it is connected the computer, the computer screen displays a warning message. If you do not take any action within the next minute, the camera turns off. You can turn the camera back on by turning the mode lever toward  or . However, the power-saving function is not active when the communication settings are set to [PTP].
- All procedures performed with a connection to a USB 2.0 compliant board are not guaranteed.







For information about what to do after making the connection, please refer the *Software Starter Guide*.



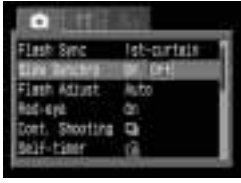

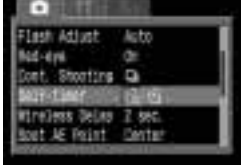

List of Menu Options and Messages

Rec. Menu





* Some items may not appear in certain shooting modes (p. 204).

*Default setting

Item	Menu Screen	Settings Content	Reference Page
Flash Sync		Sets the timing at which the flash fires. <ul style="list-style-type: none"> • 1st-curtain* • 2nd-curtain 	102
Slow Synchro		Sets the slow synchro. <ul style="list-style-type: none"> • On • Off* 	61
Flash Adjust		Sets whether or not the flash is adjusted automatically. <ul style="list-style-type: none"> • Auto* • Manual 	100
Red-eye		Sets whether or not the red-eye reduction lamp fires. <ul style="list-style-type: none"> • On* • Off 	61
Cont. Shooting		Sets the continuous shooting option. <ul style="list-style-type: none"> •  (Standard)* •  (High speed) 	73
Self-timer		Sets the duration before the self-timer releases the shutter once the shutter button is pressed. <ul style="list-style-type: none"> • 2 seconds • 10 seconds* 	70













Item	Menu Screen	Settings Content	Reference Page
Wireless Delay		<p>Sets the duration before the self-timer releases the shutter once the remote control shutter button is pressed.</p> <ul style="list-style-type: none"> • 0 seconds • 2 seconds* • 10 seconds 	175
Spot AE Point		<p>Sets the Spot AE Point option, Center (the AE point is fixed to the center) or AF Point (the AE point corresponds to the AF point).</p> <ul style="list-style-type: none"> • Center* • AF Point 	83
ND Filter		<p>Sets the ND filter.</p> <ul style="list-style-type: none"> • On • Off* 	110
MF-Point Zoom		<p>Sets whether or not the focusing point is magnified when using the manual focus.</p> <ul style="list-style-type: none"> • On* • Off 	106
AF Mode		<p>Sets the frequency of autofocus activation. When the LCD monitor is off, this setting locks in single mode.</p> <ul style="list-style-type: none"> • Continuous* • Single 	108
AF-assist Beam		<p>Sets the output of the AF-assist beam according to shooting conditions when using the auto focus.</p> <ul style="list-style-type: none"> • On* • Off 	40

Rec. Menu (continued)

Item	Menu Screen	Settings Content	Reference Page
Digital Zoom		Sets whether or not the digital zoom combines with the optical zoom to zoom images. <ul style="list-style-type: none"> • On • Off* 	72
Review		Sets the duration images display on the LCD monitor after the shutter button is released. <ul style="list-style-type: none"> • Off • 2 sec.* to 10 sec. 	53
Intervalometer		Shoots automatically at set intervals.	103
Save Settings		Saves settings selected in the shooting menu and the function menu to the mode dial's C1 or C2 mode.	109







Replay Menu

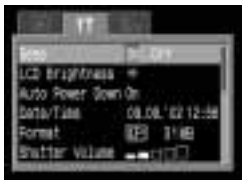

*Default setting

Item	Menu Screen	Settings Content	Reference Page
 Protect		Protects images from accidental erasure.	128
 Rotate		Rotates images 90 or 270 degrees clockwise in the display.	121
 Erase all		Erases all images from a CF card (excluding protected images).	130
 Slide Show		Plays images in an automated slide show.	124
 Print Order		Sets the images that will be printed on a DPOF-compatible printer or at a photo lab service, the number of copies and other parameters.	145
 Transfer Order		Sets the images that will be transferred with your e-mail software.	152

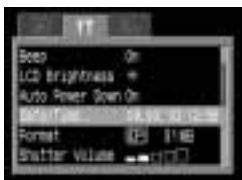
Set up Menu





*Default setting



Item	Menu Screen	Settings Content	Reference Page
Beep		<p>Sets whether or not the beep sounds when the shutter button is pressed or when a menu operation is performed. (The main dial does not beep even if it is clicked.)</p> <p>See also "How the [Beep] setting in the [T] (Set up) menu and each sound setting in the [C] (My Camera) menu are related" on page 167.</p> <ul style="list-style-type: none"> • On* • Off (Still beeps to warn of an error even when set to Off) 	39
LCD Brightness		<p>Sets the brightness level of the LCD monitor.</p> <ul style="list-style-type: none"> •  (Normal)* •  (Bright) 	-
Auto Power Down		<p>Sets whether or not the camera automatically powers down after a specified period of time elapses without something being pressed.</p> <ul style="list-style-type: none"> • On* • Off 	30
Date/Time		Sets the date, time and date format.	24
Format		Formats (initializes) a CF card.	131

Item	Menu Screen	Settings Content	Reference Page
Shutter Volume		<p>Adjusts the sound volume when the shutter button is pressed all the way. There is no shutter sound in Movie mode.</p> <ul style="list-style-type: none"> • □□□□ (Off) • ■□□□ (1) • ■■□□ (2)* • ■■■□□ (3) • ■■■■□ (4) • ■■■■■ (5) 	46
Playback Vol. (Replay)		<p>Adjusts the sound volume when a sound annotation or a movie is played.</p> <ul style="list-style-type: none"> • □□□□ (Off) • ■□□□ (1) • ■■□□ (2)* • ■■■□□ (3) • ■■■■□ (4) • ■■■■■ (5) 	117 / 122
Start-up Vol.		<p>Adjusts the sound volume when the camera powers up.</p> <ul style="list-style-type: none"> • □□□□ (Off) • ■□□□ (1) • ■■□□ (2)* • ■■■□□ (3) • ■■■■□ (4) • ■■■■■ (5) 	29

Set up Menu (continued)

*Default setting









Item	Menu Screen	Settings Content	Reference Page
Operation Vol.		Adjusts the sound volume of the Operation Sound. <ul style="list-style-type: none"> • □□□□ (Off) • ■□□□ (1) • ■■□□ (2)* • ■■■□□ (3) • ■■■■□□ (4) • ■■■■■ (5) 	39
Selftimer Vol.		Adjusts the sound volume of the Selftimer Sound. <ul style="list-style-type: none"> • □□□□ (Off) • ■□□□ (1) • ■■□□ (2)* • ■■■□□ (3) • ■■■■□□ (4) • ■■■■■ (5) 	70
File No. Reset		Sets how file numbers are assigned to images when new CF cards are inserted. <ul style="list-style-type: none"> • On • Off* 	112
Auto Rotate		Sets whether or not images shot with the camera on end are automatically rotated in the display. <ul style="list-style-type: none"> • On* • Off 	111
Distance Units		Sets the format of the displayed distance units. <ul style="list-style-type: none"> • m / cm* • ft / in 	106











Item	Menu Screen	Settings Content	Reference Page
Language		<p>Sets the language used in the menus and messages on the LCD monitor. The menu may appear differently in some regions.</p> <ul style="list-style-type: none"> • English* • Deutsch • Français • Nederlands • Dansk • Suomi • Italiano • Norsk • Svenska • Español • Chinese • Japanese <p>You can change the language during image replay by holding the SET button and pressing the JUMP button. (Except when the camera is connected to a printer)</p>	26
Video System		<p>Sets the video output signal standard.</p> <ul style="list-style-type: none"> • NTSC • PAL 	154
Communication		<p>Sets the camera and computer communication settings.</p> <ul style="list-style-type: none"> • Normal* • PTP 	157



My Camera Menu



You can select the theme, start-up image and sound, shutter sound, operation sound and selftimer sound used on this camera. These are called My Camera settings. You can also customize the **[P2]** and **[P3]** options for each item with sounds and images recorded on the CF card or by using the supplied software. See the *Software Starter Guide* for details.

*Default setting













Item	Menu Screen	Settings Content	Reference Page
Theme		<p>Selects a common theme for each My Camera settings item. *¹</p> <ul style="list-style-type: none"> •  (Off) • 1 * • 2 • 3 	46
Start-up Image		<p>Sets the start-up image when you turn on the camera.</p> <ul style="list-style-type: none"> •  (Off) • 1 * • 2 • 3 	46
Start-up Sound		<p>Sets the start-up sound when you turn on the camera. *¹</p> <ul style="list-style-type: none"> •  (Off) • 1 * • 2 • 3 	46
Operation Sound		<p>Sets the sound when the omni selector or any button other than the shutter button is operated. *¹</p> <ul style="list-style-type: none"> •  (Off) • 1 * • 2 • 3 	46

Item	Menu Screen	Settings Content	Reference Page
Selftimer Sound		Sets the sound informing you that the photo will be taken in 2 seconds.* ¹ <ul style="list-style-type: none"> •  (Off) •  * •  •  	46
Shutter Sound		Sets the shutter sound when you depress the shutter button. There is no shutter sound while a movie is being shot.* ¹ <ul style="list-style-type: none"> •  (Off) •  * •  •  	46

*¹ How the [Beep] setting in the [ (Set up)] menu and each sound setting in the [ (My Camera)] menu are related

- To actually turn off the sound of the start-up sound, shutter sound, operation sound, and self-timer sound individually, [Beep] in the [ (Set up)] menu must be set to [Off]. If [Beep] is set to [On], the beep sounds even if each sound item in the [ (My Camera)] menu is set to [Off].

For details, see the table below.

		The settings of [Beep] in the [ (Set up)] menu	
		[On]	[Off]
The settings of each sound item in the [ (My Camera)] menu ([Start-up Sound]/[Shutter Sound]/[Operation Sound]/[Selftimer Sound])		● [Beep]	–
		● []	● []
		● []	● []
		● []	● []

● : The sound specified in [] sounds.

– : No sound

Resetting the Settings to Default

You can reset the menu and button operation settings to default except for the [Date/Time], [Language], and [Video System] settings.

- 1 Turn on the camera.
 - You can turn on the camera into either Shooting or Replaying mode.

- 2 Press the **MENU** button for longer than 5 seconds.
 - The message “Reset settings to default?” appears on the LCD monitor.

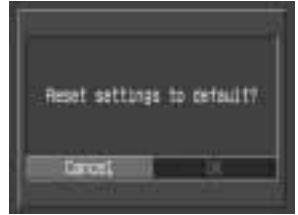

- 3 Select [OK] using the ◀ or ▶ arrow on the omni selector, then press the **SET** button.
 - The screen on the right appears while resetting. The normal screen resumes when resetting is complete.
 - To cancel resetting, select [Cancel] instead of [OK].



-
- When the camera is in shooting mode, only the **C1 / C2** mode settings will revert to default when the shooting mode dial is turned to **C1 / C2**.
 - Settings cannot be reset when the camera is connected to a computer, to a direct print function compatible printer (optional) or to a direct print function compatible BJ printer (optional).

List of Error / Message Codes

The following error and message codes may appear on the display panel.

Error Codes

E_{xx} : The camera has experienced a problem. Turn off the power, wait a second, and then try shooting or replaying. If the error code appears repeatedly, there is a problem. Note the error code number and take the camera in for servicing. If an error code appears immediately after a shot, there is a chance that the image was not recorded. Check the image in replay mode.

Message Codes

P_b : Replaying image.

P_C : Connected to computer in PC connection mode.

 : Adequate battery charge.

 : Low battery charge. Charge the battery as soon as possible to use for any length of time.

 : Battery charge low, camera will not operate. Immediately recharge or replace the battery pack with a charged one.
L_b : Could also indicate that the battery cover is open. Close the cover securely.

CF : No CF card in camera, CF card slot cover is open, or CF card error.

LENS : Power turned on with lens cap on. Remove cap, then turn power off and on again.

Int : Intervalometer is set (shoots images automatically at set time intervals). (the number of remaining shots display after the first images is shot.)

List of Messages

The following messages may appear on the LCD monitor.

Reset settings to default?:	Do you wish to reset all the camera and menu settings to default?
Resetting:	Resetting all the camera and menu settings to default
Busy... :	Image is being recorded to, or read from, CF card. Resetting settings to default.
No CF card:	You attempted to shoot or replay images without a CF card installed.
Cannot record!:	You attempted to shoot an image without a CF card installed.
CF card error!:	CF card has experienced an anomaly.
CF card full:	CF card is too full to save more images or print settings.
Naming error!:	The file could not be created because there is a file with the same name as the directory that the camera is attempting to create, or the highest possible file number has already been reached. In the Rec. menu, please set [File No.] Reset to [On]. After you save all the images you wish to retain onto a computer, format the CF card (p. 131). Please note that formatting will erase all the existing images and other data.
Change the battery pack:	Battery charge is insufficient to operate the camera. Replace it immediately with a charged battery pack or recharge it.
No image:	No images recorded on CF card.
Image too large:	You attempted to replay an image larger than 3200 x 2400 pixels.
Incompatible JPEG format:	You attempted to replay an incompatible JPEG file.
Corrupted data:	You attempted to replay an image with corrupted data.

RAW:	You attempted to replay an image recorded in an incompatible RAW format.
Cannot magnify!:	You attempted to magnify an image that was photographed with another camera, recorded in a different format, or edited on a computer.
Cannot rotate:	You attempted to rotate an image that was photographed with another camera, recorded in a different format, or edited on a computer.
Unidentified Image:	You attempted to replay an image that was recorded in a special format (proprietary format used by the camera of another manufacturer, etc.).
Incompatible WAVE format:	Cannot attach sound annotation to the image because the image has some sound file recorded in an inappropriate format.
Protected!:	You attempted to erase a protected image.
Too many marks:	Too many images have been marked for printing or for inclusion in a slide show. Cannot process any more.
Cannot mark image:	You attempted to set the print settings for a non-JPEG file.
Cannot complete!:	Couldn't save the print or slide show settings.
Cannot edit:	Slide show settings file is corrupted
Cannot register this image!:	You attempted to register an image recorded with another camera as a start-up image.
Cannot change!:	You attempted to change to the RAW format an image that was shot with the digital zoom or that was already recorded in the RAW format.

List of Messages (continued)

The following messages may appear on the camera's LCD monitor when a Direct Print compatible printer is printing. Depending on the printer model, some messages may not display.

No Paper:	Paper cassette is incorrectly inserted or out of paper. Or the paper feed isn't operating correctly.
No Ink:	The ink cartridge has not been inserted or has run out of ink.
Incompatible paper size:	Wrong paper size is loaded in the printer.
Incompatible ink size:	Wrong ink cassette size is loaded in the printer.
Ink Cassette Error:	The ink cassette is experiencing a problem.
Paper and ink do not match:	The paper and ink are from different sets.
Paper Jam:	The paper jammed during printing.
Paper has been changed:	Paper was changed after the print menu was displayed.
Recharge the printer battery:	The printer's battery pack is depleted.
Communication Error:	The printer is experiencing a data transmission error.
Readjust trimming:	You attempted to print the image with a different style than the one used when the trimming settings were set.
Cannot Print!:	You attempted to print an image from another camera, one recorded in a different format, or one that has been edited on a computer.
Could not print xx images:	You attempted to use the DPOF print settings to print xx images that are from another camera, that have been recorded in a different format, or that have been edited on a computer.

The following messages may appear when the camera is connected to the Direct Print compatible Bubble Jet Printer.

Check the error number displayed on the control panel of Bubble Jet Printer and refer to the Bubble Jet Printer Quick Start Guide.

Printer in use:	The printer is printing the data from the memory card inserted in the computer or printer. The printer automatically starts printing the images from the camera after completing the current printing.
Printer warming up:	Printer is warming up. When it is ready, the printer starts printing automatically.
No printhead:	No print head is installed in the printer.
Printer cover open:	Close the printer's front cover securely.
Media type error:	You selected a paper type incompatible with the printer. Select a compatible paper type in the Print Style menu.
Paper lever error:	Adjust the paper thickness lever to the proper position.
Low ink level:	The ink tank needs to be replaced soon. Prepare a new ink tank. If you select [Continue] in the error screen, you can restart printing.
Waste tank full:	You can restart printing by pressing the RESUME/CANCEL button on Bubble Jet Printer. Please request replacement of the waste tank to the shop where you purchased the printer or your nearest Canon customer support center listed in the Contact List provided with the Bubble Jet Printer or in the Bubble Jet Quick Start Guide.
Printer error:	Turn off the printer, then turn it on again. If the error persists, please consult your nearest Canon customer support center listed in the Contact List provided with the Bubble Jet Printer or in the Bubble Jet Quick Start Guide.



Using the Wireless Controller

Installing the Battery

Install the date battery (CR2025) into Wireless Controller WL-DC100 before use.



- Be particularly careful to keep the date batteries out of the reach of children. Seek medical assistance immediately if a child swallows a battery since corrosive battery fluids could damage the stomach or intestinal wall.

1

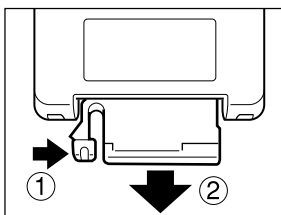

Place your fingertip on ① and press it in the direction of the arrow while placing another fingertip on ② and removing the battery holder.

2

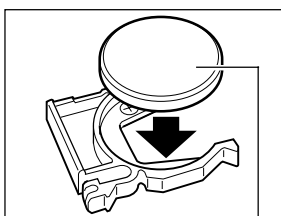

Negative Terminal (-)

Place the date battery in the battery holder with the negative terminal (-) facing up.

3

Replace the battery holder into the wireless controller.

Removing the Battery

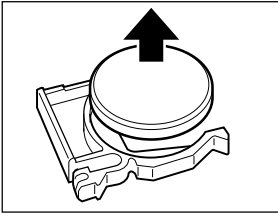

To remove the date battery, pull it in the direction of the arrow.

If you ever dispose of your camera, first remove the date battery for recycling according to the recycling system of your country.



Shooting / Replaying

The wireless controller can be used to shoot or replay. The wireless controller can be operated from an approximate distance of up to 5 m (16.4 ft.) from the front remote sensor (②) and approximately 3 m (9.83 ft.) from the side remote sensor (①).

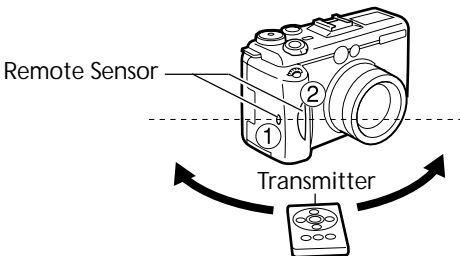

When the Macro Ring Lite MR-14EX or the Macro Twin Lite MT-24EX is mounted on the camera, it will block the front remote sensor ②. In this case, aim the wireless controller toward the side remote sensor ①.

📷 Shooting

Press the / button on the camera until the icon appears in the display panel, then shoot the image.

-
- (1) Compose the image with the zoom buttons.
 - (2) Press the shutter button.
The camera will shoot the image after the time set in [Wireless Delay] in the shooting menu has elapsed (0 seconds, 2 seconds or 10 seconds).
 - (3) Each press of this button cycles the LCD monitor to the next display mode. The order is LCD monitor on (no display), LCD monitor on (detailed display) and LCD monitor off.

Using the Wireless Controller (continued)

▶ Replaying

The  icon appears in the display panel.

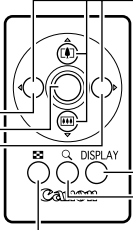
- 
- Display the previous image
 - Replay the movie images
 - Display the next image
 - In magnified mode, these buttons move the magnified area around the image.
 - In index replay, these buttons move the image selection.
 - The display mode changes with each press of the button.
 - The display cycles between magnifications of approximately 2.5, 5 and 10.
 - Display images in sets of nine (index replay).



- The operable range of the wireless controller will shorten under the following circumstances.
 - When the wireless controller is used at an angle to the remote sensor.
 - When strong light strikes the camera.
 - When the battery is weak.



- The movie editing and printing functions are not available.

Using an Externally Mounted Flash (Optional)

You can make your flash photography even clearer and more natural appearing with the use of a separately sold externally mounted flash. The camera's auto exposure function will operate with a Canon Speedlite 220EX, 380EX, 420EX, 550EX, a Macro Ring Lite MR-14EX or a Macro Twin Lite MT-24EX (p. 180). (Except with the **M** mode or when [Flash Adjust] is set to [Manual].) Other flashes may fire manually or not fire at all. Please check the manual for your flash.

- Certain functions noted in the manuals for the Canon Speedlite 220EX, 380EX, 420EX, 550EX, the Macro Ring Lite MR-14EX and Macro Twin Lite MT-24EX cannot be performed when mounted on this camera. Please read this guide before using one of these flashes on the camera.

1

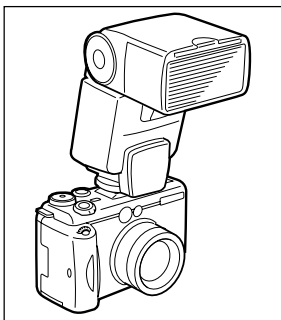

Attach the flash to the camera's hot shoe.



2

Turn the external flash on and turn the mode lever to  (Shooting).

3

Turn the mode dial to a position other than  or .

Speedlite 220EX, 380EX, 420EX, 550EX, Macro Ring Lite MR-14EX or Macro Twin Lite MT-24EX

- The flash will automatically adjust its output in the **AUTO**, , , , **P**, **Tv** and **Av** modes when [Flash Adjust] is set to [Auto]. The maximum flash synchro shutter speed is 1/250 second.
- In **M** mode or when [Flash Adjust] is set to [Manual], the flash will fire with manual adjustments. The maximum flash synchro shutter speed in this case is 1/250 second. Set the aperture to an appropriate value according to the flash's guide number and the distance to the subject. Check the camera's ISO sensitivity setting since the flash's guide number will change with the ISO value.

- When [Flash Adjust] is set to [Manual], the flash output can be adjusted. When [Flash Adjust] is set to [Auto] the flash exposure compensation can be adjusted (p. 100).
- In **M** mode or when [Flash Adjust] is set to [Manual], the output of an externally mounted flash can be adjusted in the flash output adjustment screen (p. 101). When a Speedlite 550EX, a Macro Ring Lite MR-14EX or a Macro Twin Lite MT-24EX is mounted on the camera, you can adjust the flash output from either the flash or the camera. To set it from the flash, you are recommended to use the flash's manual mode. You can also adjust the flash output even when the camera is set to the E-TTL automatic flash exposure compensation mode by changing the flash exposure compensation setting. In this situation, the +2 step setting fires the flash at full intensity.
To shoot with the flash, you are recommended to set the white balance to the  (Flash) setting.

Other Canon Flashes



- Since other flashes fire at full strength, set the shutter speed and aperture accordingly. Set the shutter speed to 1/125 second or slower, and set the aperture to a value appropriate to the flash's guide number and the distance to the subject. You are recommended to set the white balance to  (Flash) to shoot.

4 Press the shutter button halfway to focus.

- The flash is charged when its pilot lamp lights up.

5 Press the shutter button all the way to shoot the image.



- The externally mounted flash will not fire in ,  or continuous shooting.
- The Bracket mode cannot be used for flash photography. If the flash fires, only one image gets recorded.
- Please note that proprietary high-voltage flashes with multi contacts or flash accessories made by other manufacturers may cause a camera malfunction.



- The following functions can be used with a Speedlite 220EX, 380EX, 420EX or 550EX.
 - Auto Exposure (Use the E-TTL mode with a 550EX)
 - FE Lock (Not available in **M** mode)
 - Flash Sync (1st-curtain/2nd-curtain) (2nd-curtain-priority with Speedlite 550EX)
 - Daylight Synchro
 - Slow Synchro
 - Flash Exposure Compensation (When Speedlite 550EX is used, if flash exposure adjustments are made both from the camera and the flash, the 550EX's flash exposure compensation setting takes precedence when the flash is set to E-TTL mode. The camera's flash exposure compensation setting will not activate.)
 - Auto Zoom (Not available with the 220EX)

How to Mount Macro Ring Lite MR-14EX and Macro Twin Lite MT-24EX

The separately sold Conversion Lens Adapter LA-DC58B is required to mount Macro Ring Lite MR-14EX or Macro Twin Lite MT-24EX on the camera.

1

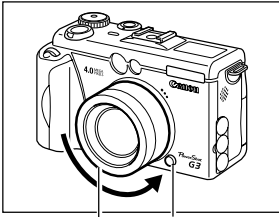

Ring Ring release button

Press the ring release button and remove the outer ring on the lens.

2

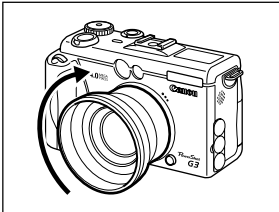

Attach Conversion Lens Adapter so that its • meets the camera's • and turn it in the direction of the arrow.

- If you plan to attach Close-up Lens 250D (p. 184), do it after you attach this adapter.

3

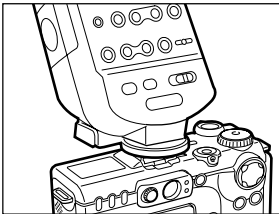

Attach the controller to the camera's hot shoe.

4

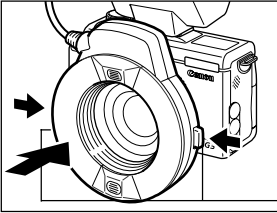

Macro Ring Lite MR-14EX

Press and hold the release buttons on both sides of Macro Ring Lite MR-14EX and fit it into the conversion lens adapter.

release buttons

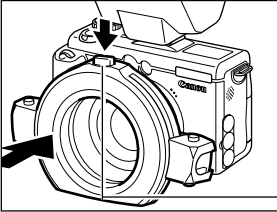

Macro Twin Lite MT-24EX

Press and hold the release button on the top of the external ring and fit it into the conversion lens adapter.

release button

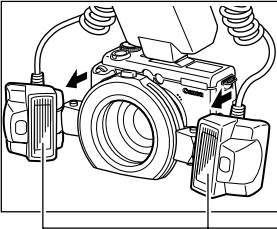

Attach Flash Heads to their respective flash head mounts.

Flash heads

5

Press the  button and set [ND filter] to [ON].

- Macro mode (p. 69)
- ND filter (p. 110)



- When you are using Macro Ring Lite MR-14EX or Macro Twin Lite MT-24EX, you can shoot in E-TTL automatic flash exposure compensation mode just by setting the camera's shooting mode to **P**, **Tv** or **Av**. You are recommended to set the aperture in **Av** or **M** mode for full-fledged macro flash photography.
- The following functions can be used with Macro Ring Lite MR-14EX or Macro Twin Lite MT-24EX mounted.
 - E-TTL Automatic Flash Exposure Compensation
 - FE Lock
 - Flash Sync (1st-curtain/2nd-curtain) (2nd-curtain priority with MR-14EX or MT-24EX)
 - Daylight Synchro
 - Slow Synchro
 - Flash Exposure Compensation
- When Macro Ring Lite MR-14EX or Macro Twin Lite MT-24EX is used, the external flash's flash exposure compensation setting takes precedence when the flash is set to E-TTL mode and a flash exposure compensation value other than 0 is set. The camera's flash exposure compensation setting will not activate unless the external flash's flash exposure compensation is set to 0.

Using Conversion Lenses (Optional) / Close-up Lenses (Optional)

The separately sold Conversion Lens Adapter LA-DC58B is required to use conversion and close-up lenses with the camera, such as the separately sold Wide Converter WC-DC58N, Tele-converter TC-DC58N and Close-up Lens 250D (58 mm). (The Wide Converter WC-DC58 and the Tele-converter TC-DC58 for the PowerShot G1/G2 are not recommended since shooting problems may occur.)



- Ensure that the wide converter, tele-converter and close-up lens are firmly screwed onto the adapter. Injury from glass shards can occur if the lens loosen and fall off.
- Never aim the wide converter, tele-converter or close-up lens directly at the sun or bright lights.

Wide Converter WC-DC58N

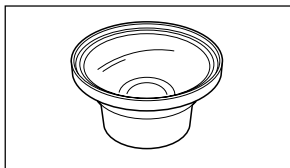

This 58 mm-threaded diameter magnifying conversion lens is for taking wide angle shots. The lens changes the focal length of the camera body's lens by a factor of 0.7x.

Tele-converter TC-DC58N

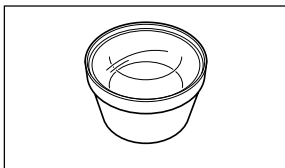

This 58 mm-threaded diameter magnifying conversion lens is for taking telephoto shots. The lens changes the focal length of the camera body's lens by a factor of 1.75x.



- An externally mounted flash may not automatically adjust its output when a conversion lens is mounted on the camera.
- Do not attach filters or lens hoods to the wide converter or tele-converter.
- When using the built-in flash to shoot, a portion of the image may be blocked by the wide converter or tele-converter and appear dark.
- When using the viewfinder to shoot, a portion of the image in the viewfinder may appear to be blocked by the wide converter or tele-converter.
- Use the wide converter lens with the focal length set to the maximum wide angle setting.
- Use the tele-converter lens with the focal length set to the maximum telephoto setting. At other zoom settings, the image will not appear correctly.

Close-up Lens 250D (58 mm)

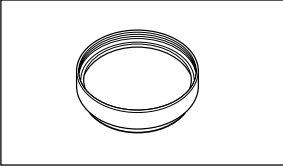

This lens, with a 58 mm-threaded diameter, makes macro shooting easier. With the camera in macro mode, it can shoot subjects as close as 10 cm (3.9 in.) from the lens tip.



- You are recommended to use Macro Ring Lite MR-14EX or Macro Twin Lite MT-24EX for flash photography with the close-up lens mounted on the camera.
- When using the built-in flash to shoot, a portion of the image in the viewfinder may appear to be blocked by the wide converter or tele-converter and appear dark.
- When using the viewfinder to shoot, a portion of the image in the viewfinder may appear to be blocked by the wide converter or tele-converter.
- Set the focal length of the camera's lens to telephoto when using the close-up lens.

Mounting the Lenses

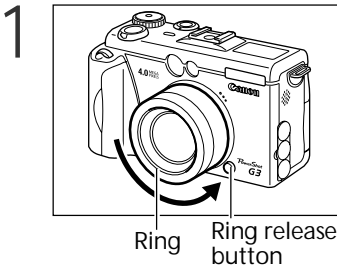

Press the ring release button and remove the ring from around the lens on the camera body.

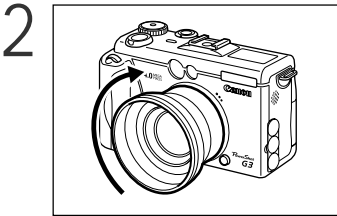

Attach the conversion lens adapter so that its • meets the camera's • and turn it in the direction of the arrow.

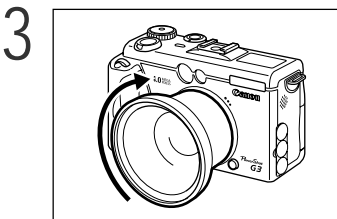

Screw on the lens in the direction of the arrows.

Wide-Converter WC-DC58N mounted



- Since the image seen in the viewfinder does not change when a conversion lens is installed, use the LCD monitor to compose images.
- Please note that the images will not merge properly with the PhotoStitch program on a computer when they are shot in  mode with a conversion or close-up lens.
- To protect the conversion lenses, hold them with one hand while you screw them on the camera with the other hand.
- Completely remove all dust and dirt from conversion lenses with a lens blower brush before use. The camera may focus on any dirt that remains.
- Exercise due caution when handling the conversion lenses since it is easy to dirty them with fingerprints.

Using a Charge Adapter / Car Battery Cable Kit (Optional)

Charge Adapter/Car Battery Cable Kit CR-560 (optional) can be used to charge battery packs or to power the camera from a car's cigarette lighter socket. You can also charge Battery Pack BP-511 or Battery Pack BP-512 (optional) from a household power source without using the camera by connecting Compact Power Adapter CA-560 (supplied with the charger adapter) to Charge Adapter/Car Battery Cable Kit CR-560.

Using a Car Cigarette Lighter Socket as a Power Source

1

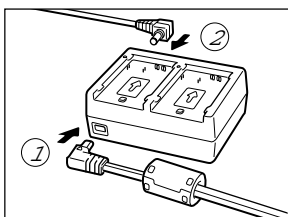

Attach the DC cable and car battery cable to the charge adapter.

2

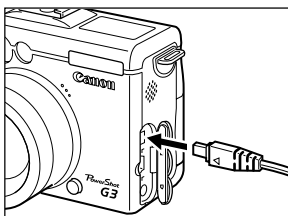

Connect the DC cable to the camera's DC IN terminal.

- Confirm that the camera's power is turned off.

3

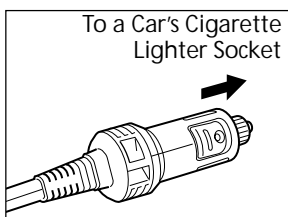

With the engine running, plug the car battery cable into the car's cigarette lighter socket.

- Be sure to have the engine running when you unplug it too.

4 Turn the camera on.



- Always ensure that the car's engine is running when you use Charge Adapter/Car Battery Cable Kit CR-560. Use of the kit without the engine running may flatten the car battery. Always unplug the kit before turning off the engine.
- The car battery charger can only be used in a negative ground car. It cannot be used in a positive ground car.

Replacing the Date Battery

If the Set Date/Time menu appears when you turn on the camera power, the date battery charge is low and the date and time settings have been lost. Please replace the battery with a generic CR2016 lithium coin battery with the following procedures.

Please note that the first date battery may appear to expire relatively quickly after you purchase the camera. This is because it is installed in the camera at the point of manufacture, not when you make the purchase.



- Be particularly careful to keep the date batteries out of the reach of children. Seek medical assistance immediately if a child swallows a battery since corrosive battery fluids could damage the stomach or intestinal wall.

1

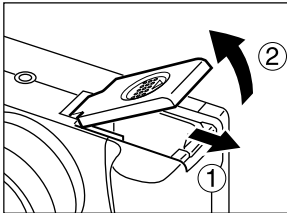

Turn off the power and slide the battery cover in the direction of the arrows (p. 19).

2

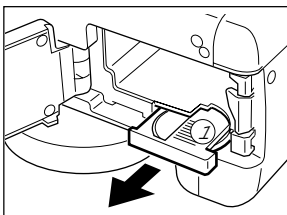

Push point ① with your fingertip while pulling the date battery holder out to remove it.

3

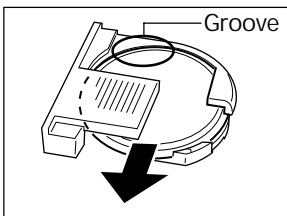

Insert a fingernail into the groove in the date battery and push it out in the direction of the arrow.

4

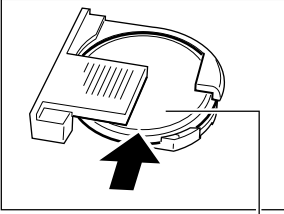

Negative Terminal (-)

Place a new date battery into the date battery holder with the negative terminal (-) facing upward.

5

Replace the date battery holder, replace the battery pack and close the battery cover.

If you ever dispose of your camera, first remove the date battery for recycling according to the recycling system of your country.





Troubleshooting

Problem	Cause	Solution
Camera will not operate	Power is not turned on	<ul style="list-style-type: none"> Turn on the camera. ➔ See <i>Turning the Power On / Off</i> (p. 28).
	CF card slot/battery cover opened	<ul style="list-style-type: none"> Confirm that the CF card slot/battery cover is securely closed.
	Insufficient battery voltage ([Lb] lights in display panel)	<ul style="list-style-type: none"> Fully charge the battery or use a household power source. Use a compact power adapter.
	Poor contact between camera and battery terminals	<ul style="list-style-type: none"> Wipe the terminals with a clean, dry cloth.
Camera will not record	Camera is in replay or computer/printer mode	<ul style="list-style-type: none"> Switch the camera to Shooting mode. ➔ See <i>Switching between Shooting and Replaying</i> (p. 31).
	Flash is charging (blinking orange indicator)	<ul style="list-style-type: none"> Wait until the orange indicator stops blinking and lights steadily, signaling that the flash is charged, then press the shutter button.
	CF card full	<ul style="list-style-type: none"> Insert a new CF card. If required, download the images to a computer and erase them from the CF card to make space.
	CF card not formatted correctly	<ul style="list-style-type: none"> Format CF card. ➔ See <i>Formatting a CF card</i> (p. 131). If reformatting doesn't work, the CF card logic circuits may be damaged. Contact the nearest Canon Customer Support Help Desk.
Lens will not retract	CF card slot/battery cover opened with camera on	<ul style="list-style-type: none"> Close the CF card slot/battery cover, then turn off the camera.
	CF card slot/battery cover opened while camera was recording to CF card (warning signal)	<ul style="list-style-type: none"> Close the CF card slot/battery cover, then close the lens cover.

Troubleshooting (continued)



Problem	Cause	Solution
Battery pack consumed quickly	Battery pack capacity reduced because of disuse for one year or more after being fully charged	<ul style="list-style-type: none"> Replace the battery pack with a new one.
	Battery life exceeded	<ul style="list-style-type: none"> Replace the battery pack with a new one.
Battery pack will not charge	The camera's power is on.	<ul style="list-style-type: none"> Turn off the camera's power.
	Battery life exceeded	<ul style="list-style-type: none"> Replace the battery pack with a new one.
	Poor contact between camera and compact power adapter	<ul style="list-style-type: none"> Clean the battery terminals with a clean dry cloth. Plug the compact power adapter's DC plug more firmly into the camera's DC IN terminal. Connect the power cord to the compact power adapter and insert its plug firmly into the power outlet.
Image is blurred or out of focus	Camera moved	<ul style="list-style-type: none"> Be careful not to move the camera when pressing the shutter button. Use a tripod at slow shutter speeds when the camera shake warning  appears.
	Autofocus function hampered by obstruction to AF-assist Beam	<ul style="list-style-type: none"> Be careful not to block the AF-assist Beam with your finger or other items.
	AF-assist Beam is set to off	<ul style="list-style-type: none"> Set the AF-assist Beam to [On]. ➔ See <i>Rec. Menu</i> (p. 158)
	Subject out of focal range	<ul style="list-style-type: none"> Ensure that there is at least 50 cm (1.6 ft.) between the camera lens and subject. Use the macro mode to shoot close-ups between 5 and 50 cm (0.16 and 1.6 ft.) at maximum wide angle and 15 and 50 cm (0.49 and 1.6 ft.) at maximum telephoto.
Subject in recorded image is too dark	Insufficient light for shooting	<ul style="list-style-type: none"> Set the built-in flash to on. Use a high-output externally mounted flash.
	Subject dark in comparison to the background	<ul style="list-style-type: none"> Set the exposure compensation to a positive (+) setting. Use the AE lock or spot metering function. ➔ See <i>Locking the Exposure Setting (AE Lock)</i> (p. 97) and <i>Switching between Light Metering Modes</i> (p. 83)

Problem	Cause	Solution
Subject in recorded image is too dark	Subject too far for flash to reach	<ul style="list-style-type: none"> • To use the built-in flash, shoot within 70 cm to 5 m (2.3 to 16.5 ft.) of the subject at the maximum wide angle and within 70 cm to 4 m (2.3 to 13.1 ft.) at the maximum telephoto setting. • Use an externally mounted flash with a large output. • Raise the ISO sensitivity and then shoot. See <i>Changing the ISO speed</i> (p. 92)
Subject in recorded image is too bright	Subject too close	<ul style="list-style-type: none"> • Adjust the flash output with the flash exposure compensation function (p. 100).
	Subject bright in comparison to the background	<ul style="list-style-type: none"> • Set the exposure compensation to a negative (-) setting. • Use the AE lock or spot metering function. ➔ See <i>Locking the Exposure Setting (AE Lock)</i> (p. 97) and <i>Switching between Light Metering Modes</i> (p. 83)
	Light shining directly on subject or reflected off subject into camera	<ul style="list-style-type: none"> • Change the shooting angle.
	Flash set to On.	<ul style="list-style-type: none"> • Set the flash to Auto or Off.
Flash will not fire	Flash set to Off.	<ul style="list-style-type: none"> • Set the flash to Auto or On.
Image not showing on TV	Incorrect video system setting	<ul style="list-style-type: none"> • Set the video system to the appropriate setting, NTSC or PAL, for your TV (p. 165).
	Shooting mode set to  (Stitch Assist)	<ul style="list-style-type: none"> • The output will not appear on a TV monitor in  (Stitch Assist) mode. Shoot in a different mode.
Zoom does not operate.	Zoom lever was moved while shooting in movie mode.	<ul style="list-style-type: none"> • Operate the zoom before shooting in movie mode.
CF card image reading is slow Recording images on the CF card takes too long	Currently used CF card has been formatted in a different device.	<ul style="list-style-type: none"> • Use a CF card formatted with this camera. ➔ See <i>Formatting a CF Card</i> (p. 131)

Specifications

All data is based on Canon's testing standard. Subject to change without notice.

PowerShot G3	
Camera effective pixels:	Approx. 4 million
Image sensor:	1/1.8 inch CCD (Total number of pixels: approx. 4.1 million)
Lens:	7.2 (W) - 28.8 (T) mm (35mm film equivalent: 35 - 140mm) F 2.0 (W) - 3.0 (T)
Digital zoom	Up to approx. 3.6 X (Up to approximately 14 times in combination with the optical zoom)
Optical viewfinder:	Real-image zoom viewfinder Field of view approx. 83% Dioptric adjustment -3 to +1m ⁻¹ (dpt equivalent)
LCD monitor:	1.8 inch, low-temperature polycrystalline silicon TFT color LCD/Field of view 100%
Autofocus method:	TTL autofocus (continuous or single) Focus lock and Manual focus are available
Focusing point:	1 focusing point (Any position is available)
Shooting distance: (from tip of the lens barrel)	Normal AF: 50 cm (1.6 ft.) - ∞ Macro AF: 5 cm (W) / 15 cm (T) - 50 cm (0.16 ft. (W) / 0.49 ft. (T) - 1.6 ft.) Manual focus: 5 cm (W) / 15 cm (T) - ∞ (0.16 ft. (W) / 0.49 ft. (T) - ∞)
Shutter:	Mechanical shutter + electronic shutter
Shutter speeds:	15 - 1 / 2000 sec. 1.3 sec. or slower shutter speeds are available in Shutter-Priority mode or Manual mode Slow shutter speeds of 1.3 sec. or more operates with noise reduction
Light metering system:	Evaluative, Center-Weighted Averaging or Spot (Center or AF Point)
Exposure control method:	Program AE, Shutter-priority AE, Aperture-priority AE or Manual exposure control AE lock is available
Exposure compensation:	± 2.0 stops (in 1/3-stop increments) Auto exposure bracketing (AEB) is available
Sensitivity (equivalent film speed) :	Auto, ISO 50, ISO 100, ISO 200 and ISO 400 equivalent
White balance:	TTL auto white balance, pre-set white balance (available settings: Daylight, Cloudy, Tungsten, Fluorescent, Fluorescent H or Flash) or Custom white balance (Custom1 / Custom2)

Built-in flash:	Auto, On, Off Red-eye reduction On: Red-eye reduction auto / Red-eye reduction On / Off Red-eye reduction Off: On / Off
Flash range:	70 cm - 5.0 m (2.3 - 16.5 ft.) (W), 70 cm - 4.0 m (2.3 - 13.1 ft.) (T) (When sensitivity is set to ISO 100 equivalent)
Terminals for external flash:	Sync-terminals at accessory shoe Use of following external flashes is recommended: Canon Speedlite 220EX, 380EX, 420EX, 550EX, Macro Ring Lite MR-14EX and Macro Twin Lite MT-24EX
Flash exposure compensation:	±2.0 stops (in 1/3-stop increments), FE lock, Slow-sync and 1st-curtain / 2nd curtain flash are available
Shooting modes:	Auto Creative zone: Program, Shutter speed priority, Aperture priority, Manual, Custom1 and Custom2 Image zone: Portrait, Landscape, Night scene, Stitch Assist and Movie
Continuous shooting:	 : Approx. 1.5 image/sec.  : Approx. 2.5 image/sec. (Large / Fine mode with LCD viewfinder off)
Self-timer:	Activates shutter after a 2-sec. / 10-sec. delay
Wireless control:	Shooting and playback are available (wireless controller is included in the camera kit) When shooting, image is captured ontime / 2-sec. / 10-sec. after shutter button pressed
PC-connected shooting:	Available (Exclusive software program is included in the camera kit)
Recording media:	CompactFlash™ (CF) card (Type I and Type II)
File format:	Design rule for Camera File system, DPOF-compliant
Image recording format:	Still images: JPEG (Exif 2.2)* ¹ or RAW Movies: AVI (Image data: Motion JPEG, Audio data: WAVE [monaural])
JPEG compression mode:	Super fine, Fine or Normal
Number of recording pixels:	Still images: Large: 2272 x 1704 pixels Medium 1: 1600 x 1200 pixels Medium 2: 1024 x 768 pixels Small: 640 x 480 pixels Movie: 320 x 240 pixels (approx. 3 min.)* 160 x 120 pixels (approx. 3 min.)* Approx. 15 frames/second * The data in parentheses refer to the maximum movie length per shooting.

Replay modes:	Single (Histogram displayable), Index (9 thumbnail images), Magnified (approx. 10x (max.) in LCD monitor), Sound annotations (up to 60 sec.), Slide Show or Image output to direct Printer (CP-100 / CP-10 and Bubble Jet Printer with the direct print function)
Languages:	12 languages available for menus and messages (English, German, French, Dutch, Danish, Finnish, Italian, Norwegian, Swedish, Spanish, Chinese and Japanese)
My Camera Settings (customizing):	The Start-up Image, Start-up Sound, Shutter Sound, Operation Sound and Selftimer Sound can be customized using the following methods. 1. Using the images and sounds recorded on the camera. 2. Using downloaded data from your computer using the supplied software.
Interface:	USB (mini-B) (Normal or PTP selectable), Audio/Video Output (NTSC or PAL selectable, monaural audio)
Power source:	1. Rechargeable Lithium-ion battery (type: BP-511) (included in the camera kit/optional) 2. Rechargeable Lithium-ion battery (type: BP-512) (optional) 3. Compact Power Adapter (CA-560) (included in the camera kit) 4. Car battery adapter (Optional Charge Adapter/Car Battery Cable Kit CR-560 is required)
Operating Temperatures:	0 - 40° C (32 - 104° F)
Operating Humidity:	10 - 90 %
Dimensions (w x h x d):	121.0 x 73.9 x 69.9 mm (4.8 x 3.0 x 2.5 in.) excluding protrusions
Weight:	Approx. 410 g (14.5 oz.) (camera body only)

*¹ This digital camera supports Exif 2.2 (also called "Exif Print"). Exif Print is a standard for enhancing the communication between digital cameras and printers. By connecting to an Exif Print-compliant printer, the camera's image data at the time of shooting is used and optimized, yielding extremely high quality prints.

Battery Performance

	Number of Images Shot		Replay Time
	LCD Monitor On	LCD Monitor Off	
Battery Pack BP-511/512 (Fully charged)	Approx. 450 images	Approx. 1050 images	Approx. 360 minutes

* The data above reflects standard Canon testing conditions. The actual figures will vary according to the shooting conditions and settings.

* Movie data is excluded.

* At low temperatures, the battery pack performance may diminish and the low battery icon appear very rapidly. In these circumstances, the performance can be improved by warming the battery pack in a pocket before use.

<Test Conditions>

Shooting: Normal temperature (23° C, 73° F), alternating wide angle end and telephoto end shots at 20-second intervals with flash fired once every four shots and camera power turned off and on every eighth shot. CF card used.

Replaying: Normal temperature (23° C, 73° F), continuous playback at one image per 5 seconds. CF card used.



• See page 17 for battery handling precautions.

CF Cards and Estimated Capacities (Recordable Images)

		FC-16M	FC-32M	FC-64M	FC-128M	FC-256MH*	
L (Large)	2272 x 1704 pixels		7	14	30	61	123
			13	27	54	110	222
			26	54	110	220	443
M 1 (Medium)	1600 x 1200 pixels		14	30	61	122	246
			26	54	109	219	440
			52	108	217	435	868
M 2 (Medium)	1024 x 768 pixels		25	53	107	215	431
			46	94	189	379	762
			84	174	349	700	1390
S (Small)	640 x 480 pixels		58	120	241	482	962
			94	196	393	788	1563
			165	337	676	1355	2720
RAW	2272 x 1704 pixels		3	7	15	31	65
Movie	320 x 240 pixels		44 sec	91 sec	183 sec	368 sec	735 sec
	160 x 120 pixels		118 sec	242 sec	486 sec	973 sec	1954 sec

- These figures reflect standard shooting conditions established by Canon. Actual totals may vary according to the subject, shooting conditions and shooting mode.
- The following are the approximate maximum recording times for movie clips:
 : 3 minutes, : 3 minutes. The maximums in the chart reflect continuous shooting.
- (Superfine), (Fine) and (Normal) indicate the relative compression ratio.
- * The Canon FC-256MH CF card is not sold in some regions.

Approximate Image File Sizes (Estimated)

Resolution	Compression		
L (2272 x 1704 pixels)	2002 KB	1116 KB	556 KB
M1 (1600 x 1200 pixels)	1002 KB	558 KB	278 KB
M2 (1024 x 768 pixels)	570 KB	320 KB	170 KB
S (640 x 480 pixels)	249 KB	150 KB	84 KB
RAW	3780 KB		
Movies	(320 x 240 pixels)	330 KB/sec	
	(160 x 120 pixels)	120 KB/sec	

Battery Pack BP-511/Battery Pack BP-512 (Optional)

Type:	Rechargeable lithium ion cell
Nominal voltage:	7.4 V
Nominal capacity:	1100 mAh
Charge cycles:	Approx. 300
Operating temperatures:	0 - 40° C (32 - 104° F)
Dimensions:	38 x 55 x 21 mm (1.5 x 2.2 x 0.8 in.)
Weight:	Approx. 70 g (2.5 oz.)

Compact Power Adapter CA-560

Input voltage	AC 100-240 V (50/60 Hz) 60 VA (100 V) - 75 VA (240 V)
Rated output:	9.5 V / 2.7 A
Operating temperatures:	0 - 40° C (32 - 104° F)
Dimensions:	57 x 28 x 104 mm (2.2 x 1.1 x 4.1 in.) (body only)
Weight:	Approx. 180 g (6.3 oz.)

Wireless Controller WL-DC100

Power supply:	Lithium button battery CR2025
Operating temperatures:	0 - 40° C (32 - 104° F)
Dimensions:	35 x 6.5 x 56.6 mm (1.4 x 0.3 x 2.2 in.)
Weight:	Approx. 10 g (0.4 oz.)



CompactFlash™ Card

Card slot type:	Type I
Dimensions:	36.4 x 42.8 x 3.3 mm (1.4 x 1.7 x 0.1 in.)
Weight:	Approx. 10 g (0.4 oz.)

Charge Adapter / Car Battery Cable Kit CR-560 (Optional)

• Charge Adapter CG-560	
Input voltage:	DC 9.5 V (when CA-560 used) DC 12/24 V (when automotive battery used)
Input current:	DC 2.5 A (when charging the battery pack)
Nominal output:	DC 8.4 V 1.6 A (when charging the battery pack) DC 9.5 1.5 A (as an adapter)
Operating temperatures:	0 - 40° C (32 - 104° F)
Dimensions:	93 x 36 x 71 mm (3.7 x 1.4 x 2.8 in.)
Weight:	Approx. 140 g (5.0 oz.)

• **Car Battery Cable CB-560**

Supported vehicles:	Cigarette lighter socket powered by a negative ground, DC 12 V or 24 V car battery
Fuse:	125 V / 4 A  
Length:	Approx. 1.8 m (6.0 ft.)
Weight:	Approx. 80 g (2.8 oz.)

Wide Converter WC-DC58N (Optional)

Magnification:	Approx. 0.7x
Focal length:	∞
Lens configuration:	3 elements in 3 groups
Focusing range (from tip of lens):	5 cm - ∞ (0.16 ft. - ∞) (when attached to a PowerShot G3 at wide angle end)
Thread diameter:	58 mm Standard filter threads (Conversion Lens Adapter LA-DC58B is required to install the lens on a PowerShot G3)
Dimensions:	Diameter: 94.5 mm (3.7 in.)/Length: 54.9 mm (2.2 in.)
Weight:	Approx. 275 g (9.7 oz.)

Tele-converter TC-DC58N (Optional)

Magnification:	Approx. 1.75x
Focal length:	∞
Lens configuration:	3 elements in 3 groups
Focusing range (from tip of lens):	50 cm - ∞ (1.6 ft. - ∞) (when attached to a PowerShot G3 at telephoto end)
Thread diameter:	58 mm Standard filter threads (Conversion Lens Adapter LA-DC58B is required to install the lens on a PowerShot G3)
Dimensions:	Diameter: 75 mm (3.0 in.)/Length: 50 mm (2.0 in.)
Weight:	Approx. 185 g (6.5 oz.)

Close-up Lens 250D (58 mm) (Optional)

Focal length:	250 mm
Focusing range (from tip of lens):	10 - 25 cm (0.33 - 0.82 ft.) (when attached to a PowerShot G3)
Thread diameter:	58 mm Standard filter threads (Conversion Lens Adapter LA-DC58B is required to install the lens on a PowerShot G3)
Dimensions:	Diameter: 60 mm (2.4 in.)/Length: 12 mm (0.5 in.)
Weight:	Approx. 80 g (2.8 oz.)

Index

A

AE Lock 97
AEB Mode 93
AF Frame 82
Aperture-Priority AE (**Av**) 79
Aperture Value 75, 77, 79, 81
Auto Exposure Bracketing (AEB Mode) 93
Auto Mode (**AUTO**) 51
Auto Replay (Slide Show) 124
Auto Rotate 111, 164
A/V Out Terminal 10, 154

B

Battery Pack
Charging 16
Handling Precautions 17
Installing 19
Low Status 20
Performance 196
Beep 162, 163, 164
Black and White Mode 89
Brightness
LCD Monitor 162

C

Camera Care and Maintenance 190
Car Battery Cable Kit 186
CF Card
Formatting 131
Handling 23
Installing 22
Recording Capacity 197
Charge Adapter 186
Cleaning 190
Communication 157, 165
CompactFlash™ Card 22, 23, 131, 197
Compact Power Adapter 16, 21
Components Guide 10
Compression 55, 197
Continuous Shooting () 73
Contrast 89
Conversion Lenses
Close-up Lens 184
Mounting the Lenses 185
Tele-converter 183
Wide Converter 183
Custom Settings 109, 160
Creative Zone 13

D

Date Battery 188
Date/Time 24, 162
Digital Print Order Format (DPOF) Settings
Print Settings 145, 150

Transfer Order 152
Digital Terminal 10, 137, 156
Digital Zoom 41, 72, 160
Display Modes 32 - 37
Detailed 35, 36
Simple 35, 36
Display Panel 15
DPOF
Print Settings 145, 150
Transfer Order 152

E

Erasing
All Images 130
Displayed Images 9
Single Images 129
Exposure
AEB 93
AE Lock 97
Aperture-Priority AE (**Av**) 79
Compensation 85
Flash Exposure Compensation 100
Shutter Speed-Priority AE (**Tv**) 77
White Balance 86
Exposure Compensation 85
Externally Mounted Flash 177

F

FE Lock 99
File Format 53, 58
File No. Reset 112
File Numbers 112
Flash 60
Exposure Compensation 100
Switching the Timing 102
Flash Exposure Compensation 100
Focal Length 41
Focus
Focus-BKT 95
Lock 105
Manual 106
Settings 108, 159
Focus Bracketing (Focus-BKT Mode) 95
Focus Setting 108
Focus-BKT Mode 95
Format 131

H

Histogram 37

I

Image Characteristics 89
Contrast 90
Saturation 90
Sharpness 90

Image Zone 13
Index Replay 115
Indicators 11
Information View 35 - 36
Interface
 Cables 10, 137, 154
Intervalometer 103, 160
ISO Speed 92

J

Jump 116

L

Landscape Mode (🌄) 63
Language Settings 26, 165
LCD Monitor 32 - 37
 Brightness 162
Lens Cap 27
Light Metering
 Center-Weighted Averaging 83
 Evaluative 83
 Spot AE Point (AF Point) 83
 Spot AE Point (Center) 83

M

Macro Mode (🔍) 69
Macro Ring Lite 180
Magnifying Images 114
Main Dial 14
Manual
 Exposure (M) 81
 Focus (MF) 106
 Setting Image Characteristics 89
 Shooting Mode 81
Menu
 List of Options 158
 Rec 158
 Replay 161
 Selecting Menus and Settings 42
 Set up 162 - 165
Messages 169
Movie (🎬)
 Editing 119
 Replaying 117
 Shooting 68
My Camera
 Menu 166
 Registering 48
 Settings 46

N

ND Filter 110, 159
Night Scene Mode (🌃) 64

O

Operation Sound 46 - 47, 164
Overexposure Warning 37

P

PC Connection Mode 157, 165
Photo Effect 89
Play 113
Portrait Mode (👤) 63
Power/Mode Indicator 28
Power On/Off 28 - 29
Power Saving 30, 162
Printing 132, 139, 150
 Print Style 147
 Resetting 149
 Selecting Images 145
 Settings 141
Program AE (P) 75
Protect 128, 161

R

RAW File Format 53, 58
Recording File Format 53, 58
Red-Eye Reduction Function 61
Replay
 Index Replay 115
 Jumping 116
 LCD Monitor 36
 Magnifying Images 114
 Movies 117
 Rotating 121
 Single Image Replay 113
 Slide Show 124
 Switching from Shooting Mode 31
 TV 154
 Volume 163
Resetting the settings to default 168
Resolution 55
Rotate 121

S

Saturation 90
Self-Timer 70
 Sound 46 - 47, 164
Sharpness 90
Shooting 28, 31, 38
 Checking Images 53
 Switching from Replaying Mode 31
 TV Set 154
Shooting Mode 204
 Dial 13
 Functions Available 204

Shutter
 Shutter Speed-Priority AE (Tv) 77
 Sound 46 - 47, 163
 Speed 75, 77, 79, 81
 Volume 163
Shutter Button 39
 Pressing Fully 39
 Pressing Halfway 39
Single Image Replay 113
Slide Show 124, 161
 Play Time 126
 Repeat 126
 Selecting Images 125
 Starting 124
Soft Case 27
Sound Annotations 122
Speaker 10
Specifications 194 - 199
Spot Light Metering 83
Start-up
 Image 30, 46 - 47, 166
 Sound 30, 46 - 47, 166
Stitch Assist Mode (□) 65
 Framing Subjects 65
 Shooting 66
Strap 27

T

Telephoto 41
Terminal cover 10
Transfer Order
 Reset 152
 Selecting Images 152
Tripod socket 11
Troubleshooting 191 - 193

V

Video System 154, 165
Viewfinder
 LCD Monitor 11, 32
 Optical 11, 38
Volume
 Replay 163
 Shooting 163

W

WAVE Files 36, 50, 122
White Balance 86
Wide Angle 41
Wireless Controller
 Installing the Battery 174
 Replaying 176
 Removing the Battery 175
 Shooting 175

Z

Zoom 41, 72, 114

FCC Notice

Digital Camera, Model PC1032

This device complies with Part 15 of the FCC Rules. Operation is subject to the following two conditions:

- (1) this device may not cause harmful interference, and
- (2) this device must accept any interference received, including interference that may cause undesired operation.

Note: This equipment has been tested and found to comply with the limits for Class B digital devices, pursuant to Part 15 of the FCC rules. These limits are designed to provide reasonable protection against harmful interference in a residential installation. This equipment generates, uses and can radiate radio frequency energy and, if not installed and used in accordance with the instructions, may cause harmful interference to radio communications. However, there is no guarantee that interference will not occur in a particular installation. If this equipment does cause harmful interference to radio or television reception, which can be determined by turning the equipment off and on, the user is encouraged to try to correct the interference by one or more of the following measures:

- Reorient or relocate the receiving antenna.
- Increase the separation between the equipment and receiver.
- Connect the equipment into an outlet on a circuit different from that to which the receiver is connected.
- Consult the dealer or an experienced radio/TV technician for help.

The cables with the ferrite core provided with the digital camera must be used with this equipment in order to comply with Class B limits in subpart B of Part 15 on FCC rules.

Do not make any changes or modifications to the equipment unless otherwise specified in the manual. If such changes or modifications should be made, you could be required to stop operation of the equipment.

Canon U.S.A. Inc.
One Canon Plaza, Lake Success, NY 11042, U.S.A.
Tel No. (516) 328-5600

Canadian Radio Interference Regulations

THIS CLASS B DIGITAL APPARATUS MEETS ALL REQUIREMENTS OF THE CANADIAN INTERFERENCE CAUSING EQUIPMENT REGULATIONS.

Réglementation canadienne sur les interférences radio

CET APPAREIL NUMERIQUE DE LA CLASSE B RESPECTE TOUTES LES EXIGENCES DU REGLEMENT SUR LE MATERIEL BROUILLEUR DU CANADA.

Functions Available in Each Shooting Mode

This chart shows the functions available in each shooting mode.
You can shoot with the settings saved in the C1 or C2 mode (p. 109).

		AUTO						P	Tv	Av	M	Reference Page
Resolution	Large L	●*	●*	●*	●*	▲*	-	●*	●*	●*	●*	55
	Medium 1 M1	●	●	●	●	▲	-	●	●	●	●	
	Medium 2 M2	●	●	●	●	▲	-	●	●	●	●	
	Small S	●	●	●	●	▲	-	●	●	●	●	
Resolution	Movie	-	-	-	-	-	●*	-	-	-	-	55
	Movie	-	-	-	-	-	●	-	-	-	-	
Compression	Superfine S	●	●	●	●	▲	-	●	●	●	●	55
	Fine	●*	●*	●*	●*	▲*	-	●*	●*	●*	●*	
	Normal	●	●	●	●	▲	-	●	●	●	●	
File Format	JPEG	●	●	●	●	●	-	●*	●*	●*	●*	58
	RAW RAW	-	-	-	-	-	-	●	●	●	●	
Flash	Auto	●*	●*	●	●*	-	-	●	-	-	-	60
	On	-	●	●	●	▲	-	●	●	●	●	
	Off	●	●	●*	●	▲*	●	●*	●*	●*	●*	
Red-eye reduction, Flash On		●	●	●	●	▲	-	●	●	●	●	61
Slow Synchro	On	-	-	●	●	▲	-	●	-	●	-	61
	Off	●	●	-	-	▲*	-	●*	●	●*	●	
Flash Adjust	On	●	●	●	●	●	-	●	●*	●*	-	100
	Off	-	-	-	-	-	-	-	●	●	●	
Flash Sync	1st-curtain	●	●	●	●	●	-	●*	●*	●*	●*	102
	2nd-curtain	-	-	-	-	-	-	●	●	●	●	
AF-assist Beam		●	●	●	●	▲	●	●	●	●	●	159
Drive Mode	Single Shot	●*	●*	●*	●*	▲*	●*	●*	●*	●*	●*	73
	Normal Continuous Mode	-	●	●	●	-	-	●	●	●	●	
	High Speed Continuous Mode	-	●	●	●	-	-	●	●	●	●	
	Self-Timer (10 sec.)	●	●	●	●	●	●	●	●	●	●	70
	Self-Timer (2 sec.)	●	●	●	●	●	●	●	●	●	●	
Intervalometer		-	-	-	-	-	-	●	●	●	●	103
AF Frame	Center Point	●	●	●	●	●	●	●*	●*	●*	●*	82
	Manual	-	-	-	-	-	-	●	●	●	●	
Manual Focus MF		-	●	●	●	●	●	●	●	●	●	106

								P	Tv	Av	M	Reference Page	
Macro Mode			●	●	-	●	●	●	●	●	●	69	
Digital Zoom	On		●	●	●	-	-	●	●	●	●	72	
	Off		●*	●*	●*	●*	-	-	●*	●*	●*		●*
Exposure Compensation			-	●	●	●	▲	●	●	●	-	85	
Light Metering Method	Evaluative Metering		●	●	●	●	●	●	●*	●*	●*	●*	83
	Center-Weighted Averaging		-	-	-	-	-	-	●	●	●	●	
	Spot Metering		-	-	-	-	-	-	●	●	●	●	
	Center		-	-	-	-	-	-	●*	●*	●*	●*	
	AF Point		-	-	-	-	-	-	●	●	●	●	
AE Lock/FE Lock			-	-	-	-	-	-	●	●	●	-	97/99
Bracket	AEB		-	-	-	-	-	-	●	●	●	-	93/95
	Focus-BKT		-	-	-	-	-	-	● ⁽¹⁾	● ⁽¹⁾	● ⁽¹⁾	● ⁽¹⁾	
White Balance ⁽²⁾		WB	- ⁽³⁾	●	●	●	▲	● ⁽⁴⁾	●	●	●	●	86
Photo Effect			-	●	●	●	▲	●	●	●	●	●	89
	Contrast/ Sharpness/Saturation		-	-	-	-	-	-	●	●	●	●	
Focus settings	Continuous		●*	●*	●*	●*	▲*	●	●*	●*	●*	●*	108
	Single		●	●	●	●	▲	-	●	●	●	●	
ISO Speed		ISO	- ⁽⁵⁾	- ⁽⁵⁾	- ⁽⁵⁾	- ⁽⁵⁾	- ⁽⁵⁾	- ⁽⁵⁾	●	●	●	● ⁽⁶⁾	92
Auto Rotate	On		●*	●*	●*	●*	▲*	-	●*	●*	●*	●*	111
	Off		●	●	●	●	▲	-	●	●	●	●	
ND Filter			-	-	-	-	-	-	●	●	●	●	110

* Default setting.

● Setting selection is possible.

▲ Setting can only be selected for the first image.

- Setting selection is not possible.

■ (Shaded Area) Setting remains in effect even when the camera is turned off.

The default for the settings changed by the menu and button operations can be restored all at once except for [Date/Time], [Language] and [Video System] (p. 168).

(1) Selectable only in manual focus.

(2) The photo effect [Sepia] and [B/W] cannot be selected.

(3) The white balance is set to [AUTO].

(4) The white balance [flash] cannot be set.

(5) The ISO speed is automatically set by the camera.

(6) ISO [AUTO] cannot be selected.

Canon